

1. Zaal
2. Parkeerkelder
3. Foyer
4. Foyer
5. Live avenue
6. Foyer
7. Vakwerk dak
8. Rigging & catwalks

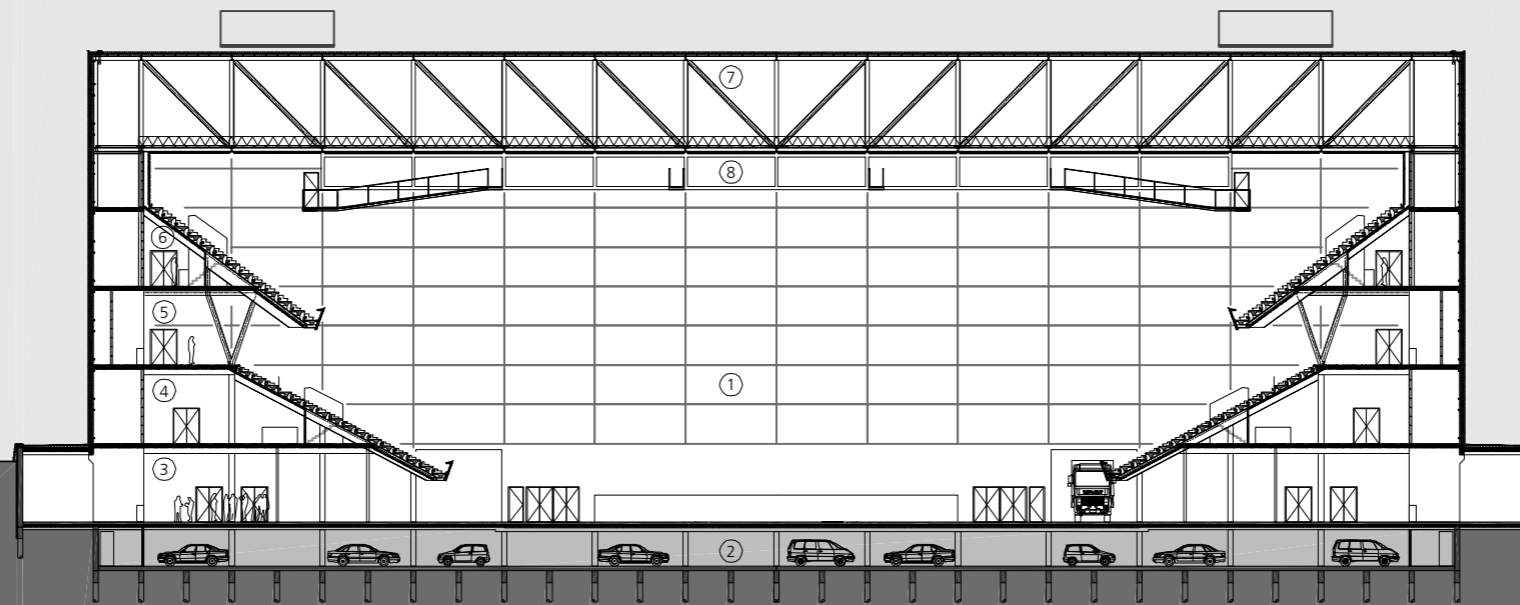

0 5 10 25m

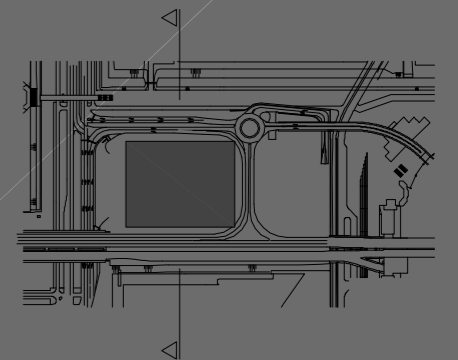

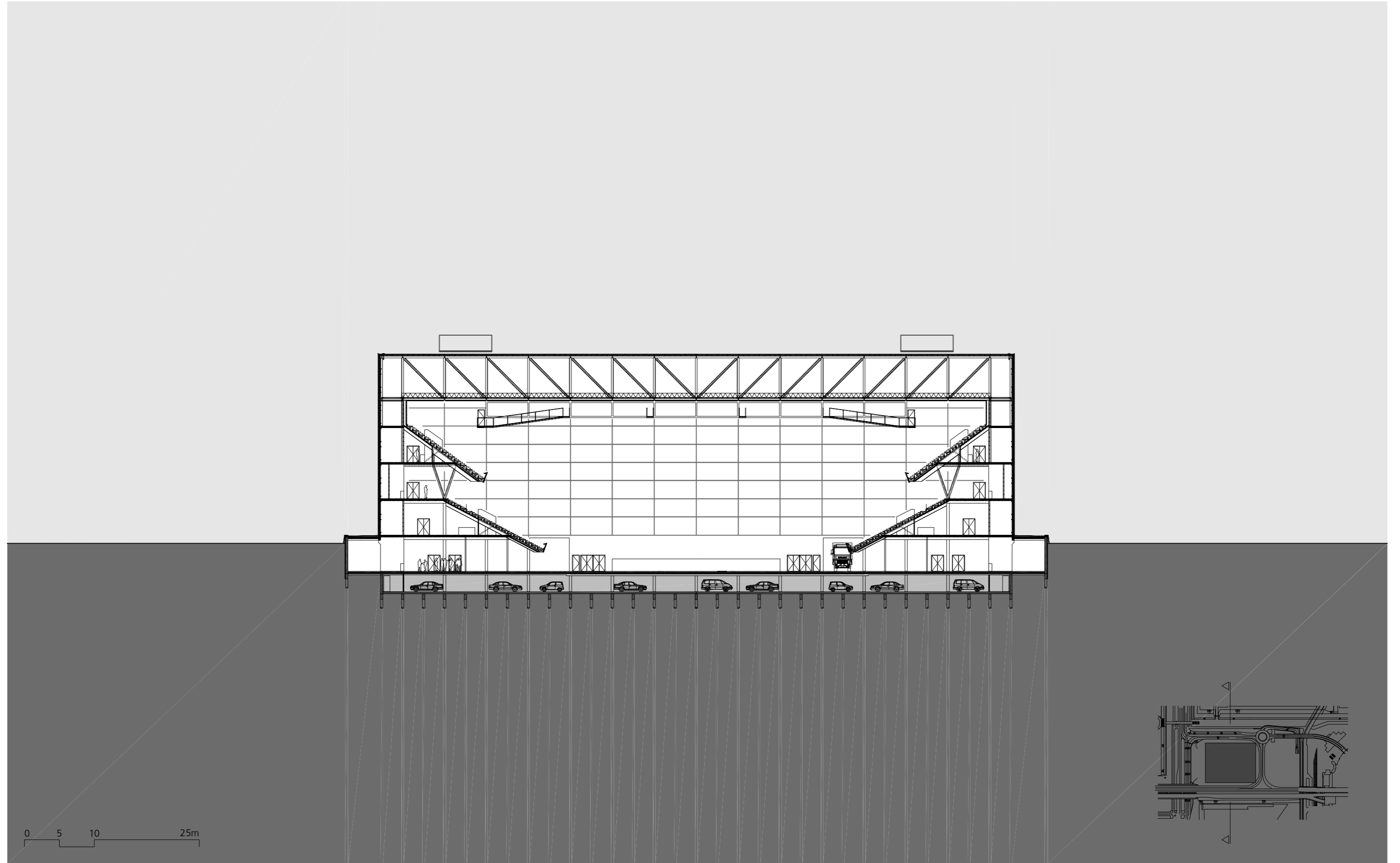

0 5 10 25m

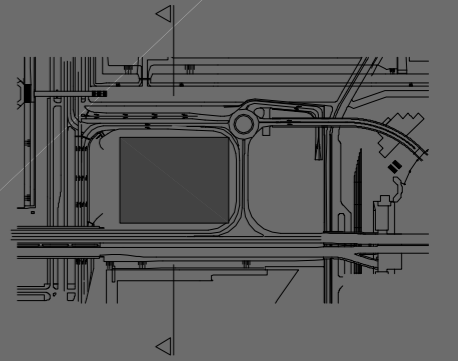

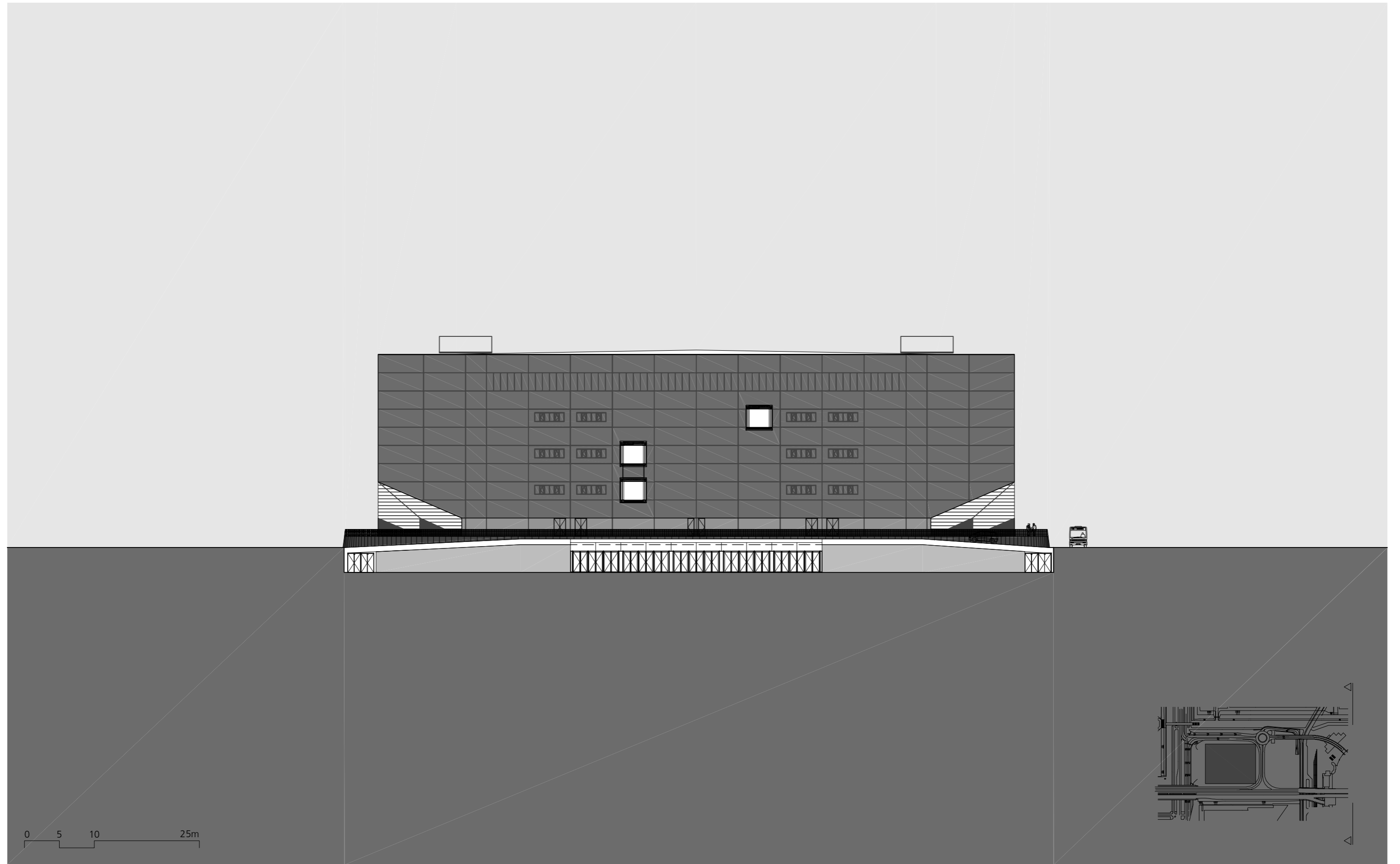

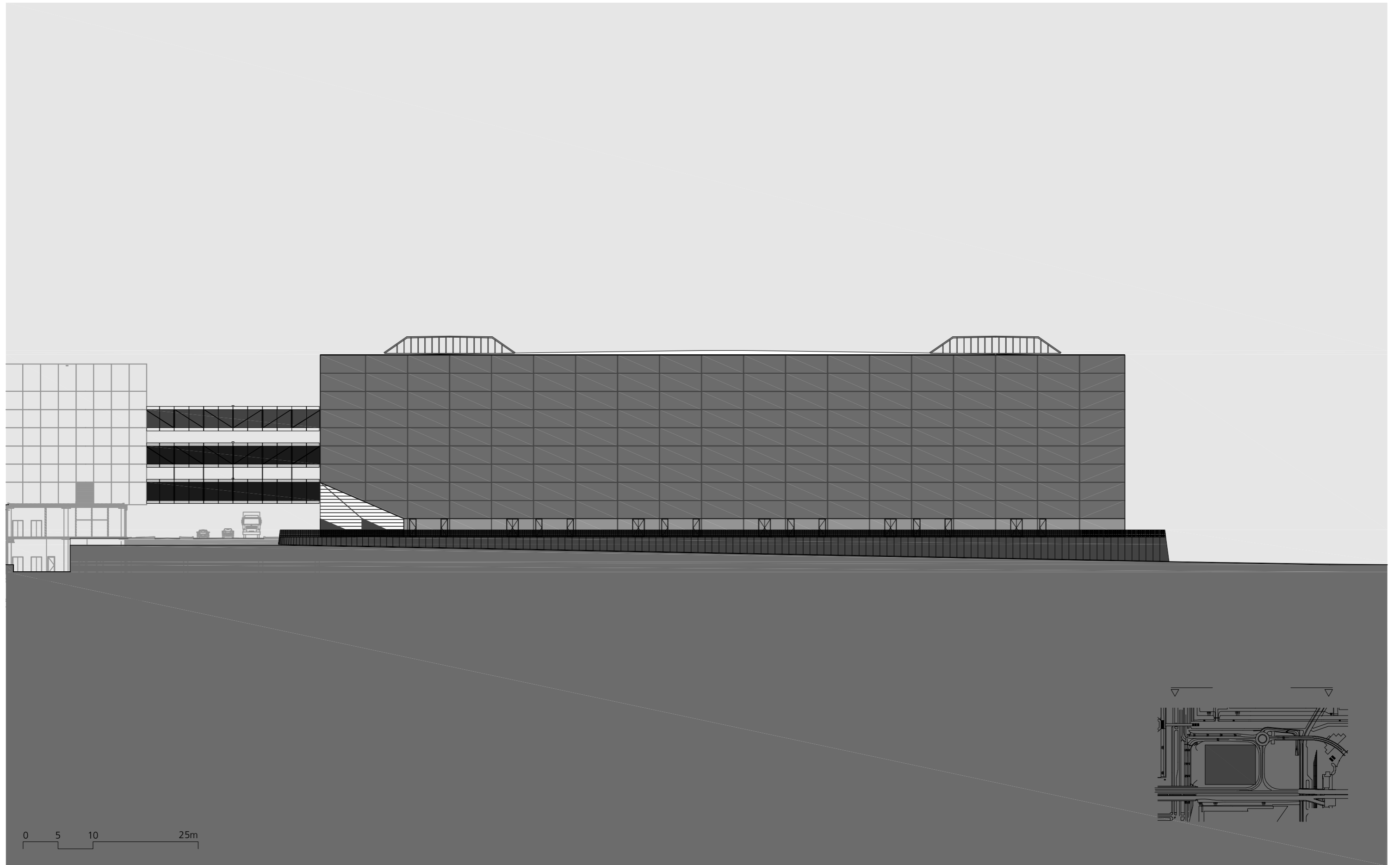

0 5 10 25m

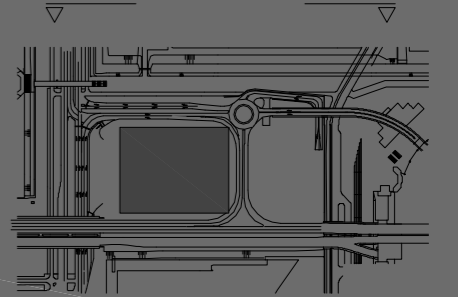

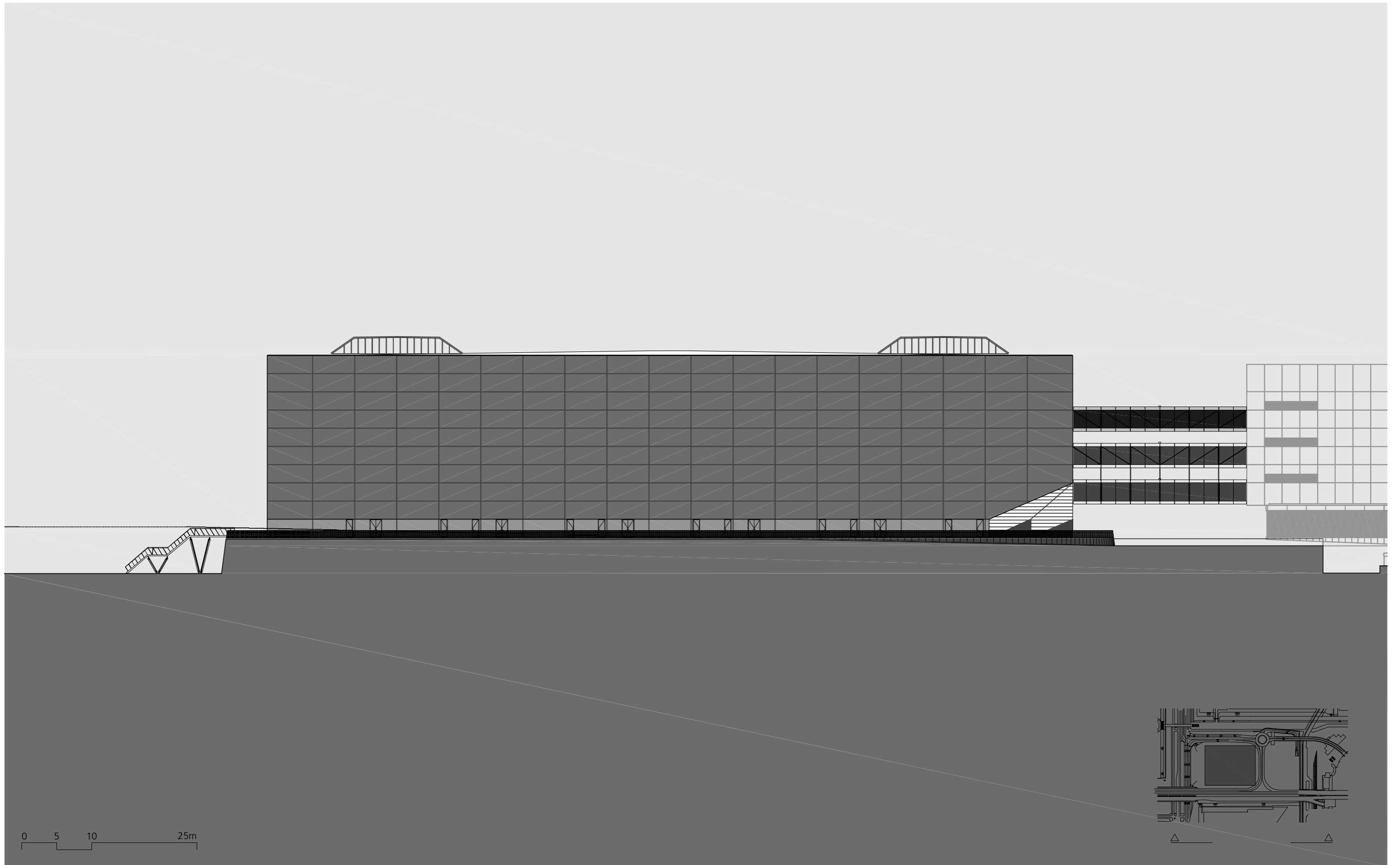

0 5 10 25m

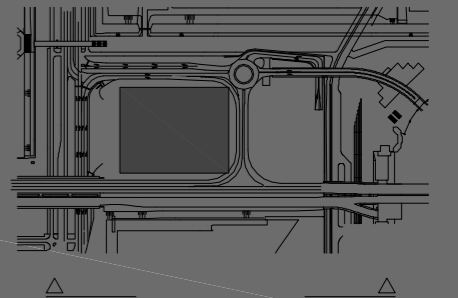

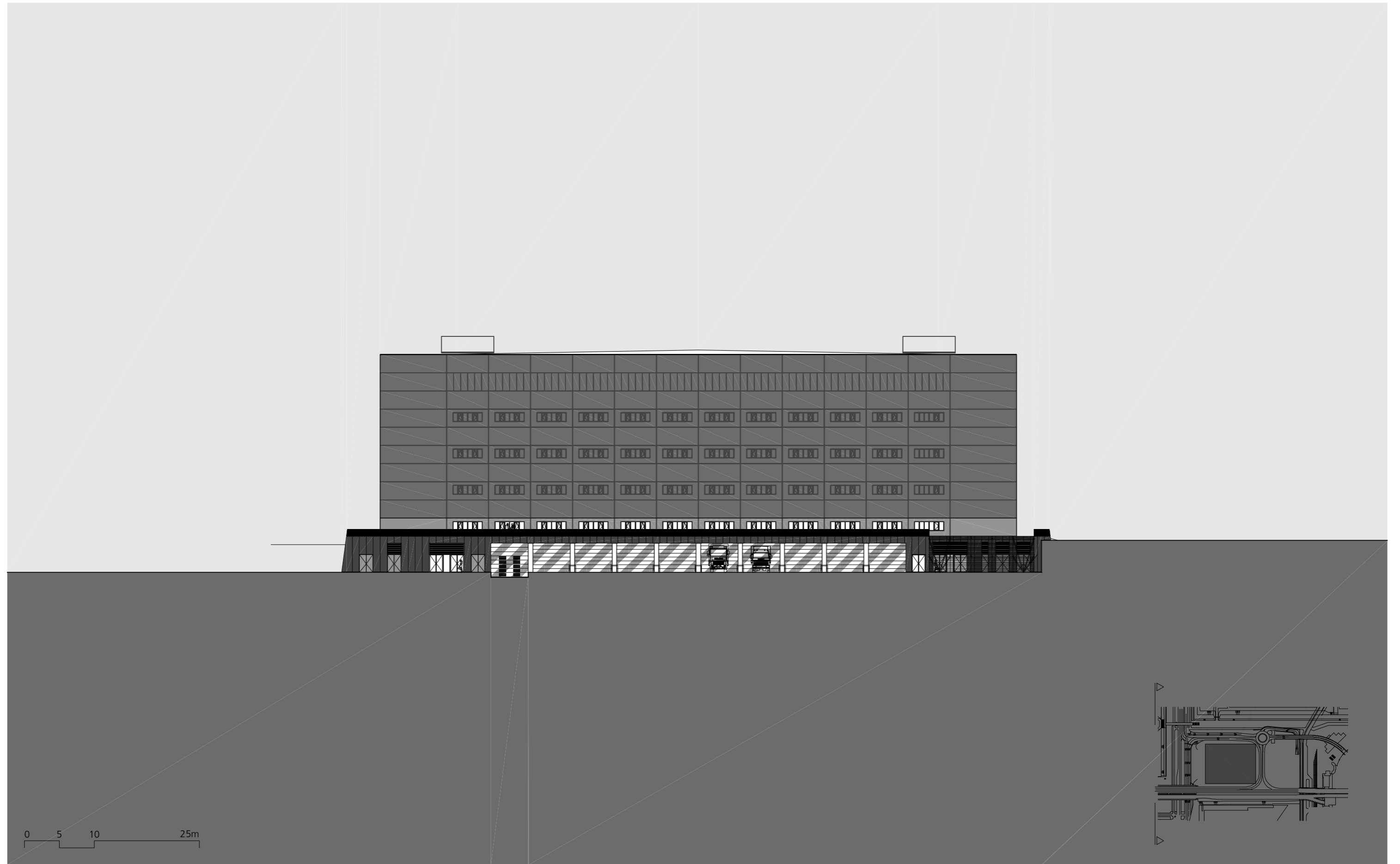

0 5 10 25m

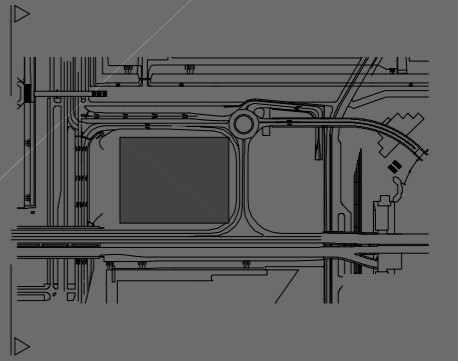

- 1. Plein
- 2. Tochtportaal
- 3. Entree
- 4. Entree VIP
- 5. Zaal
- 6. Garderobes/ kluisjes
- 7. Foyer
- 8. Bars
- 9. Food
- 10. Toiletten
- 11. Miva toiletten
- 12. Vluchtwegen
- 13. Backstage
- 14. Laad en los terrein

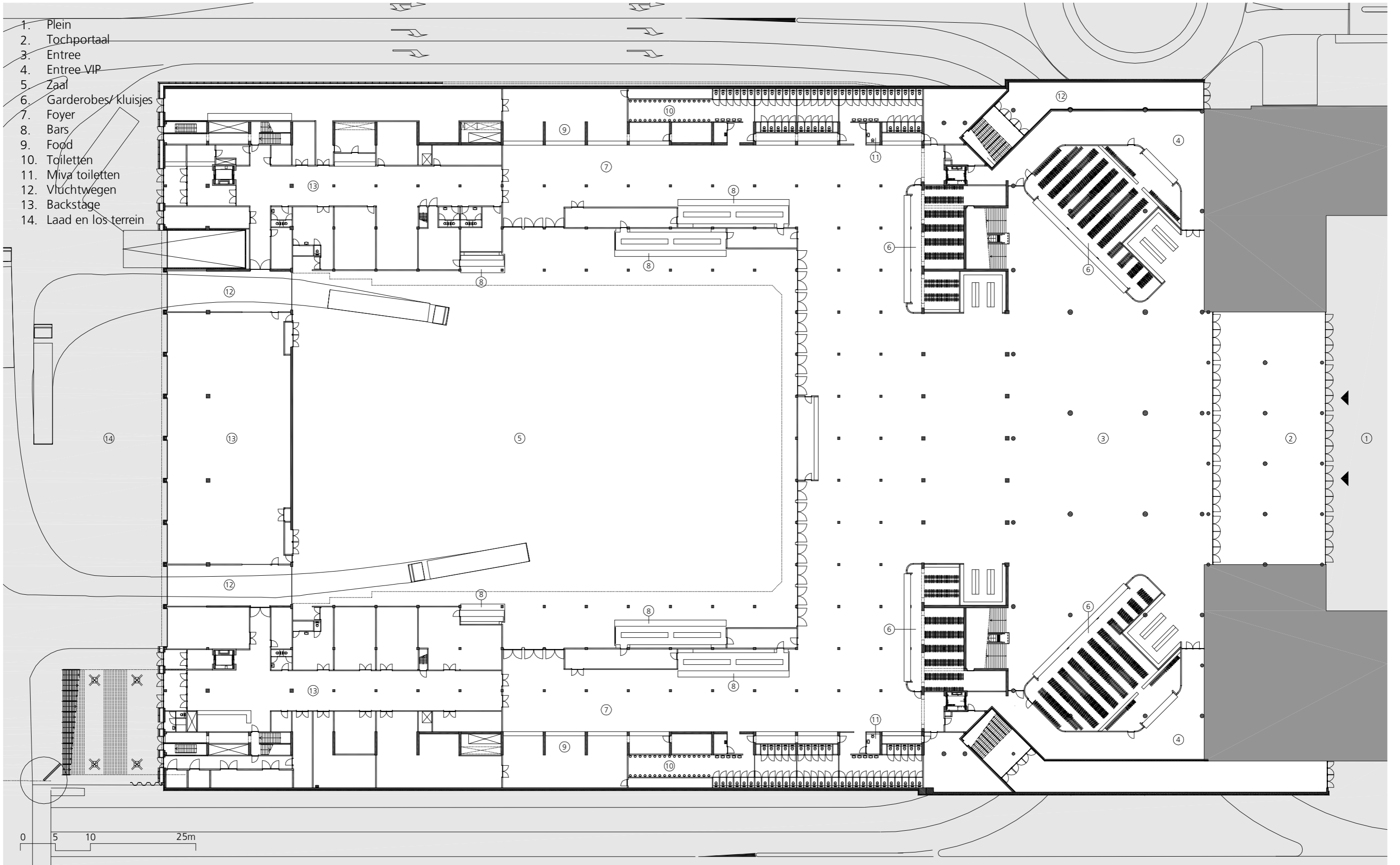

0 5 10 25m



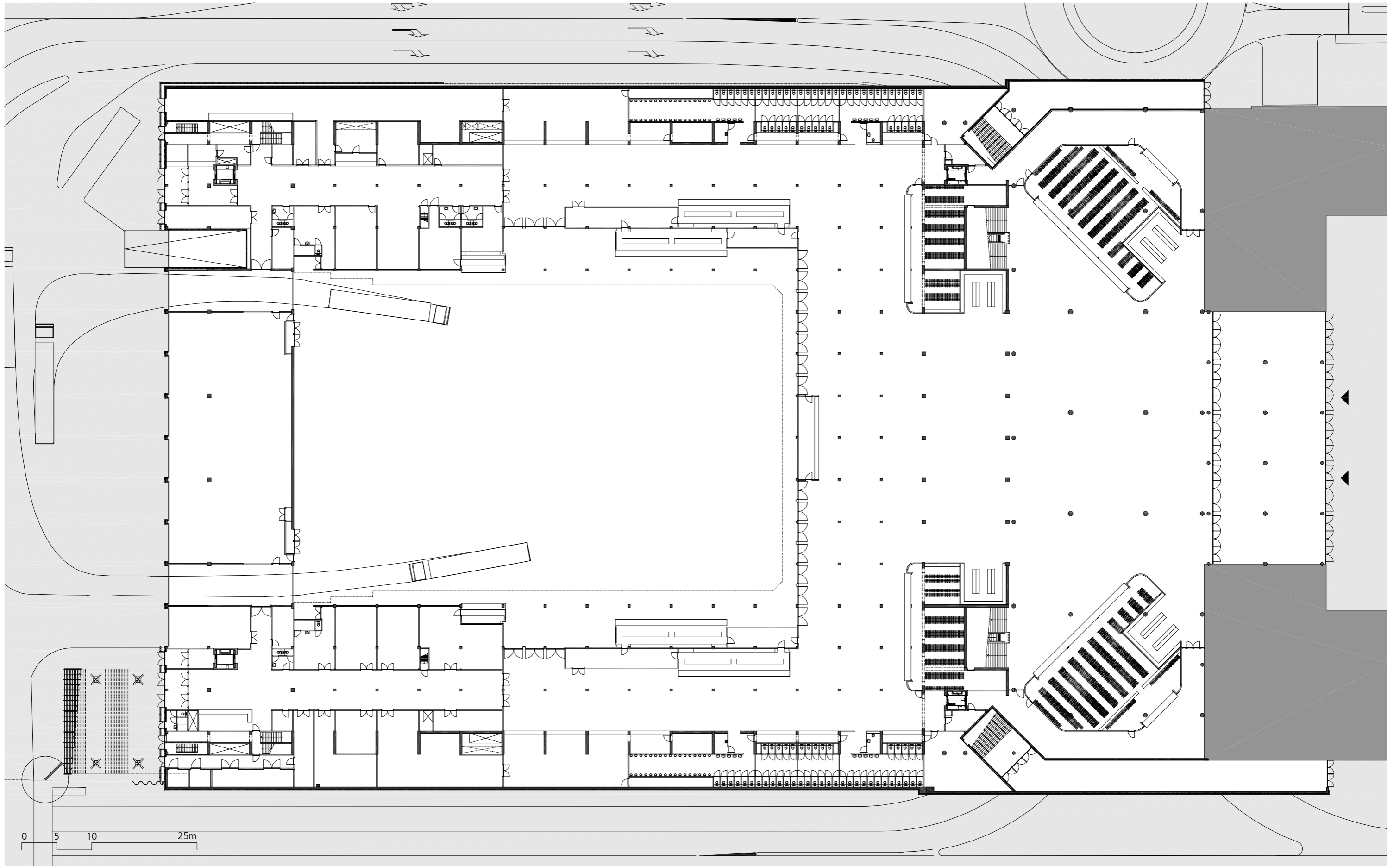

1. Trap vanuit entreegebied
2. Roltrappen naar bovenste tribune
3. Foyer
4. Tribune
5. Zaal
6. Bars
7. Cafe
8. Rookruimte
9. Toiletten
10. Vluchttrappenhuizen
11. Vluchtroute (buiten)
12. Crew catering
13. Kleedkamers

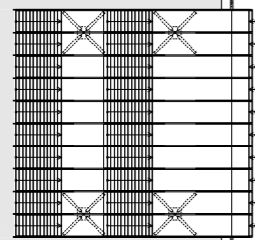
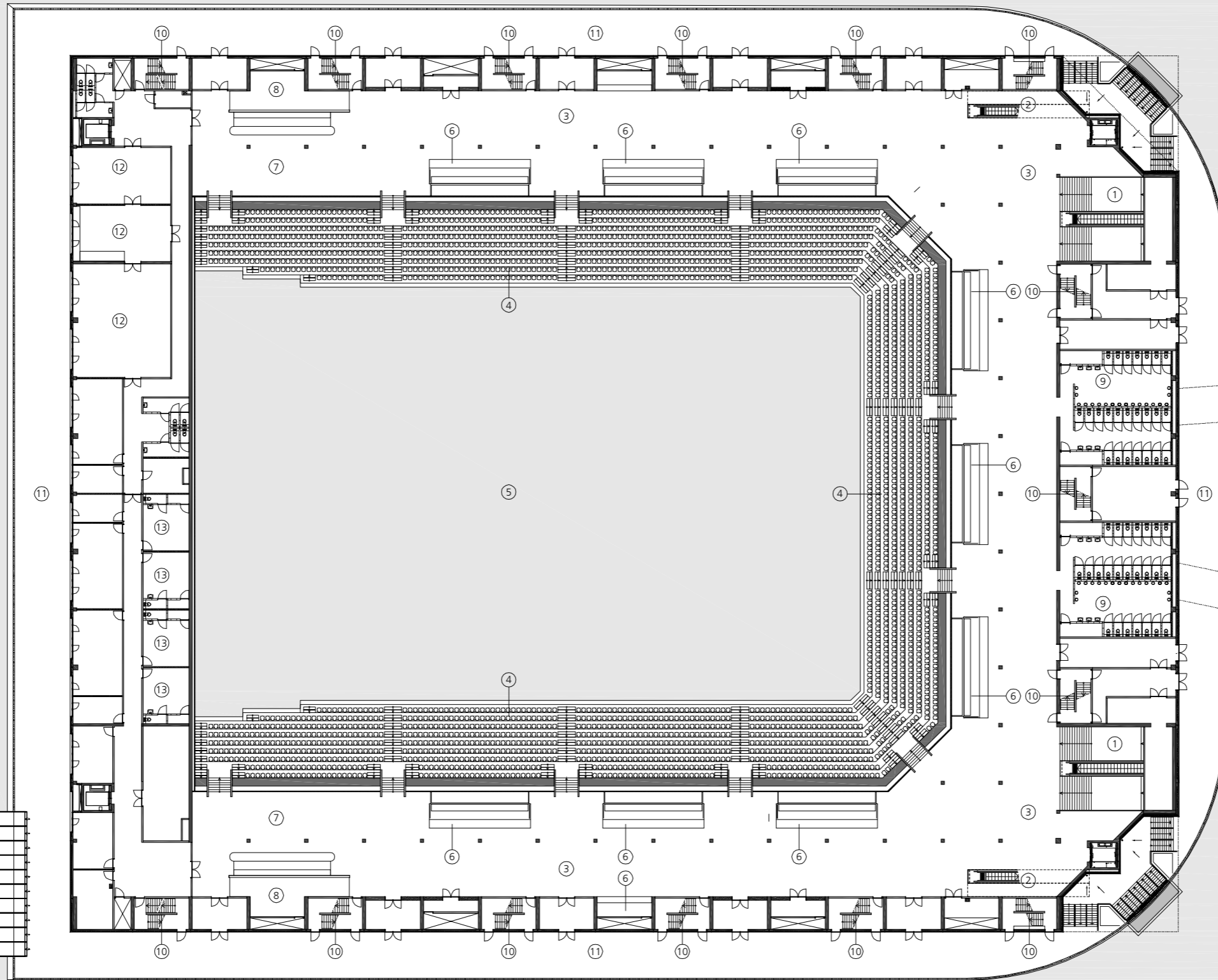

0 5 10 25m

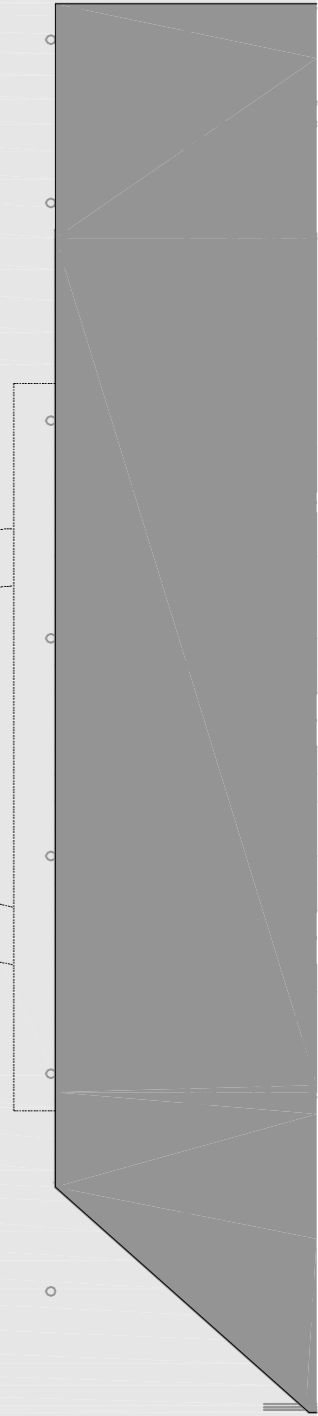
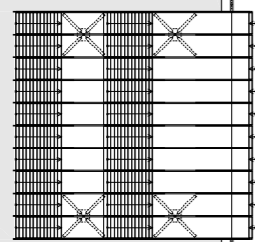
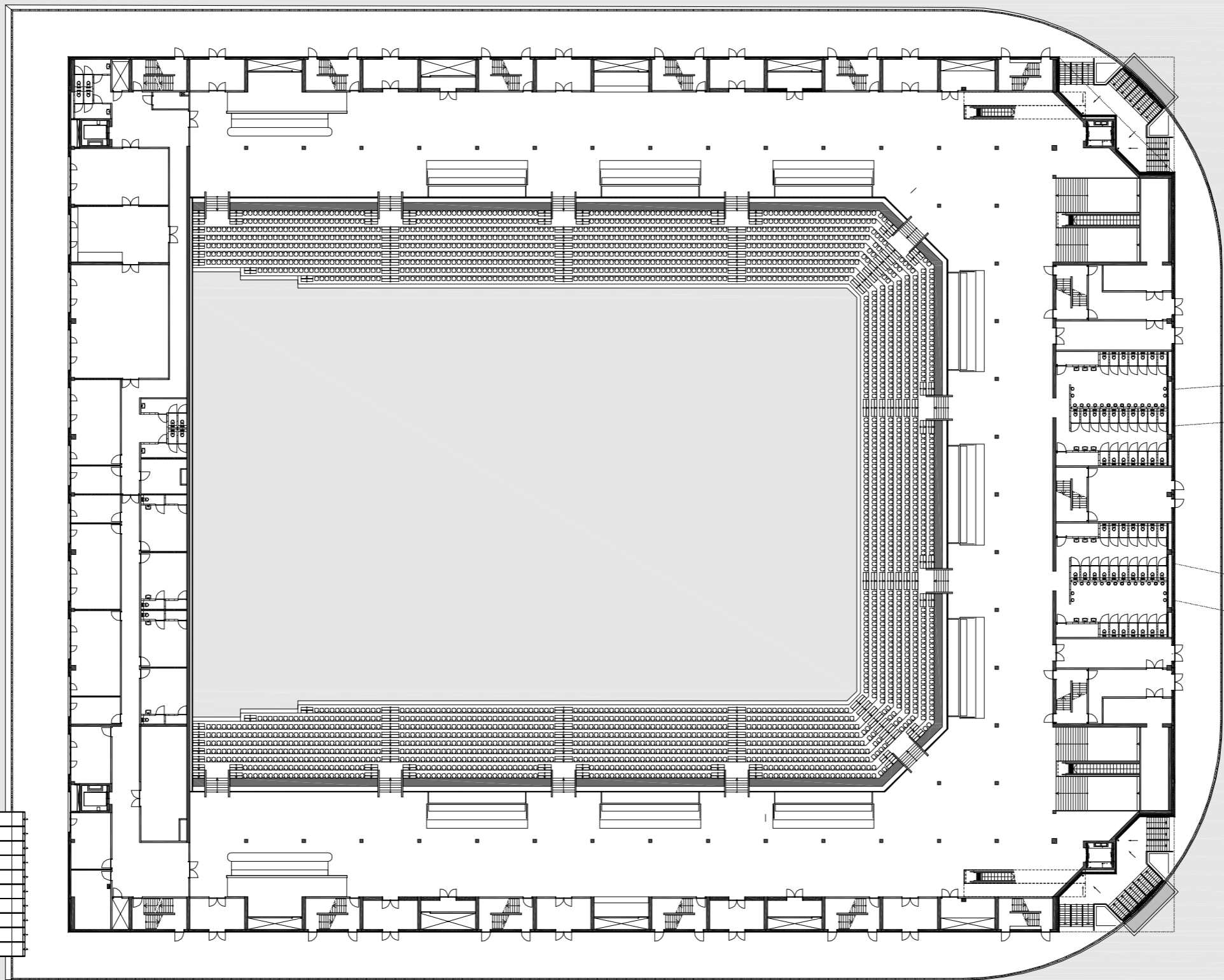

0 5 10 25m

1. Lift vanaf entree
2. Live avenue
3. Tribune
4. Zaal
5. Member lounge
6. Luchtbrug
7. Keuken
8. Toiletten
9. Miva toiletten
10. Vluchttrappenhuizen
11. Band catering
12. Kleedkamers
13. Backstage

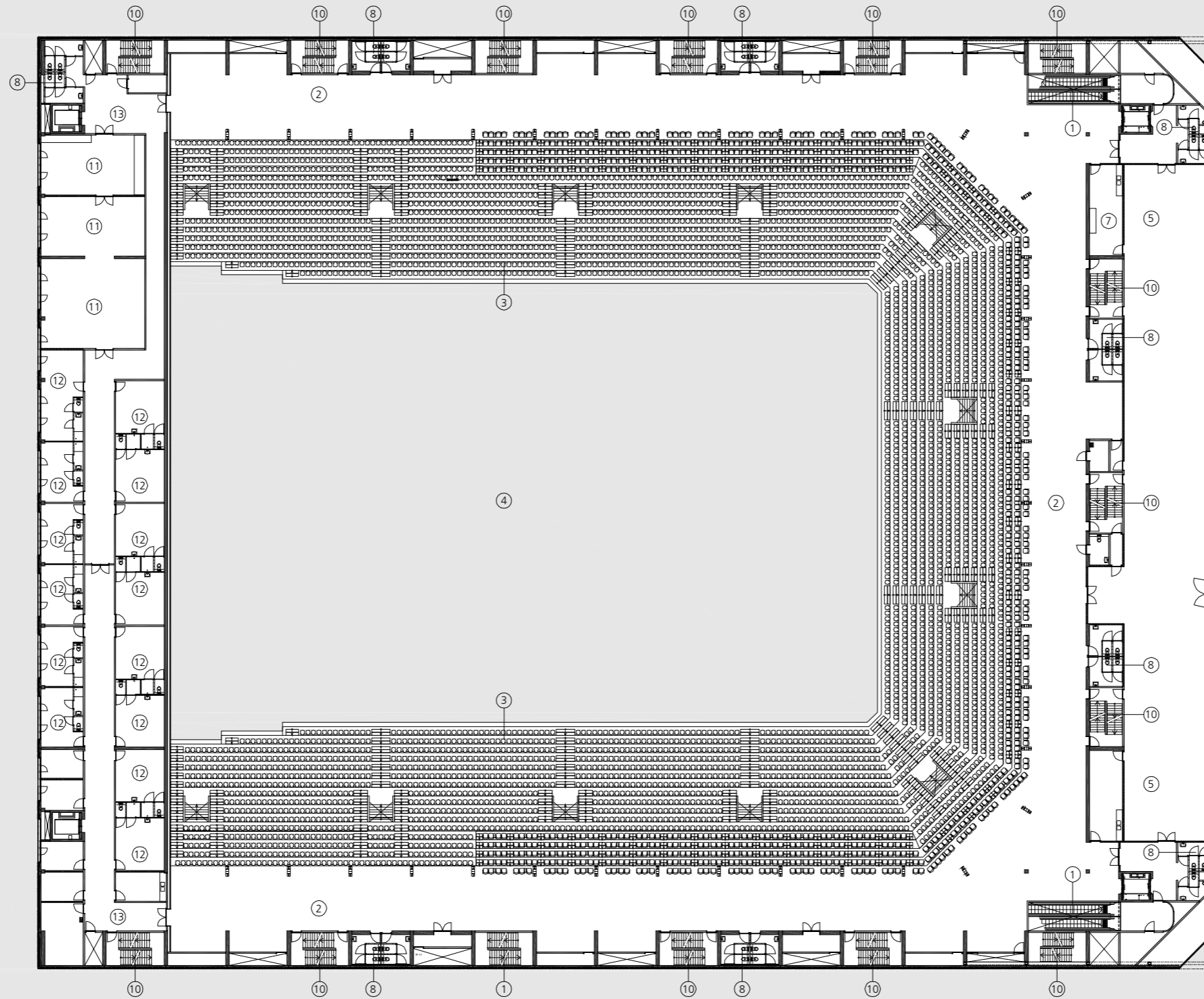

0 5 10 25m

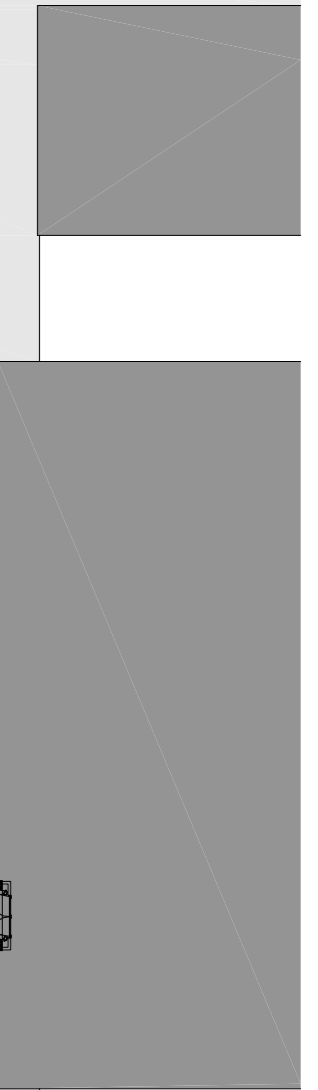

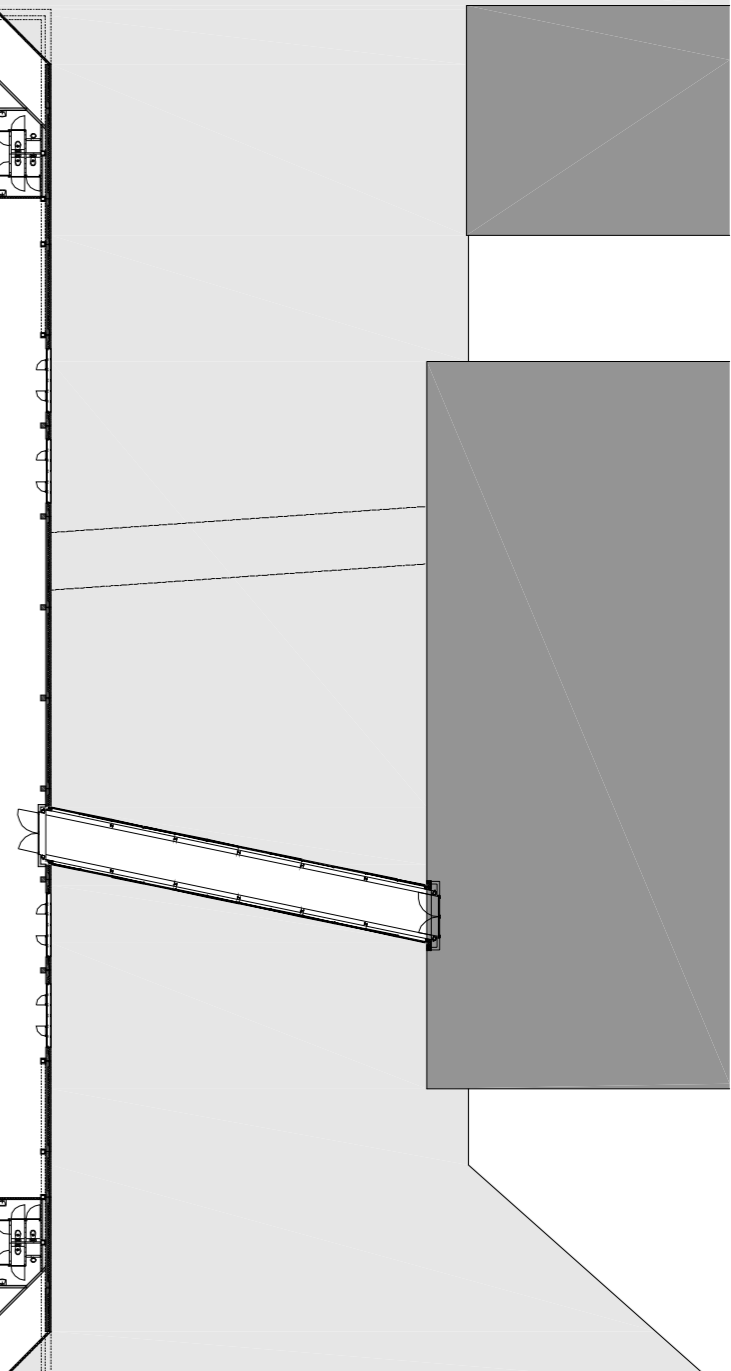
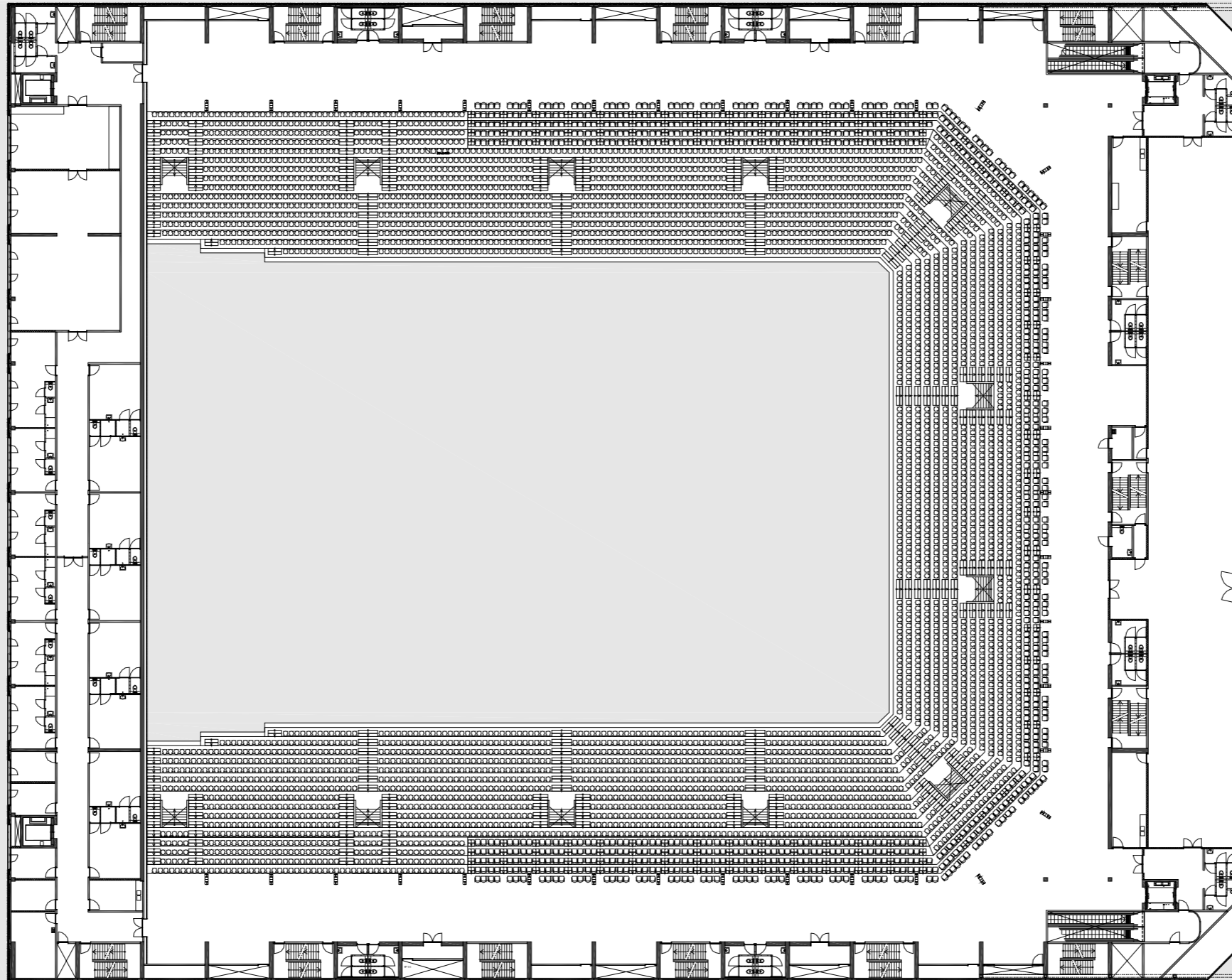

0 5 10 25m

- 1. Roltrappen
- 2. Foyer
- 3. Tribune
- 4. Zaal
- 5. Cafe
- 6. Luchtbrug
- 7. Bars
- 8. Toiletten
- 9. Vluchttrappenhuizen
- 10. Kantoren

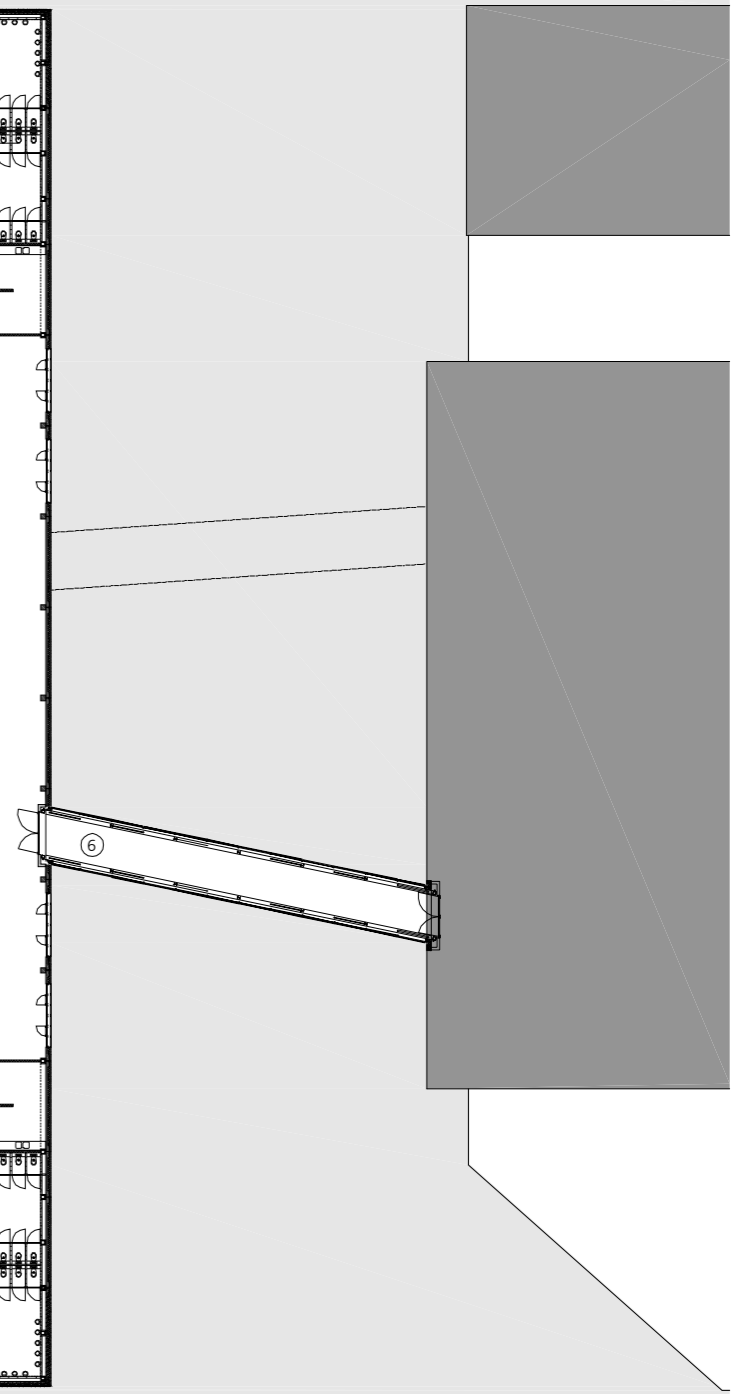
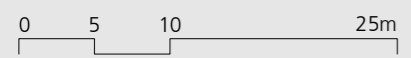
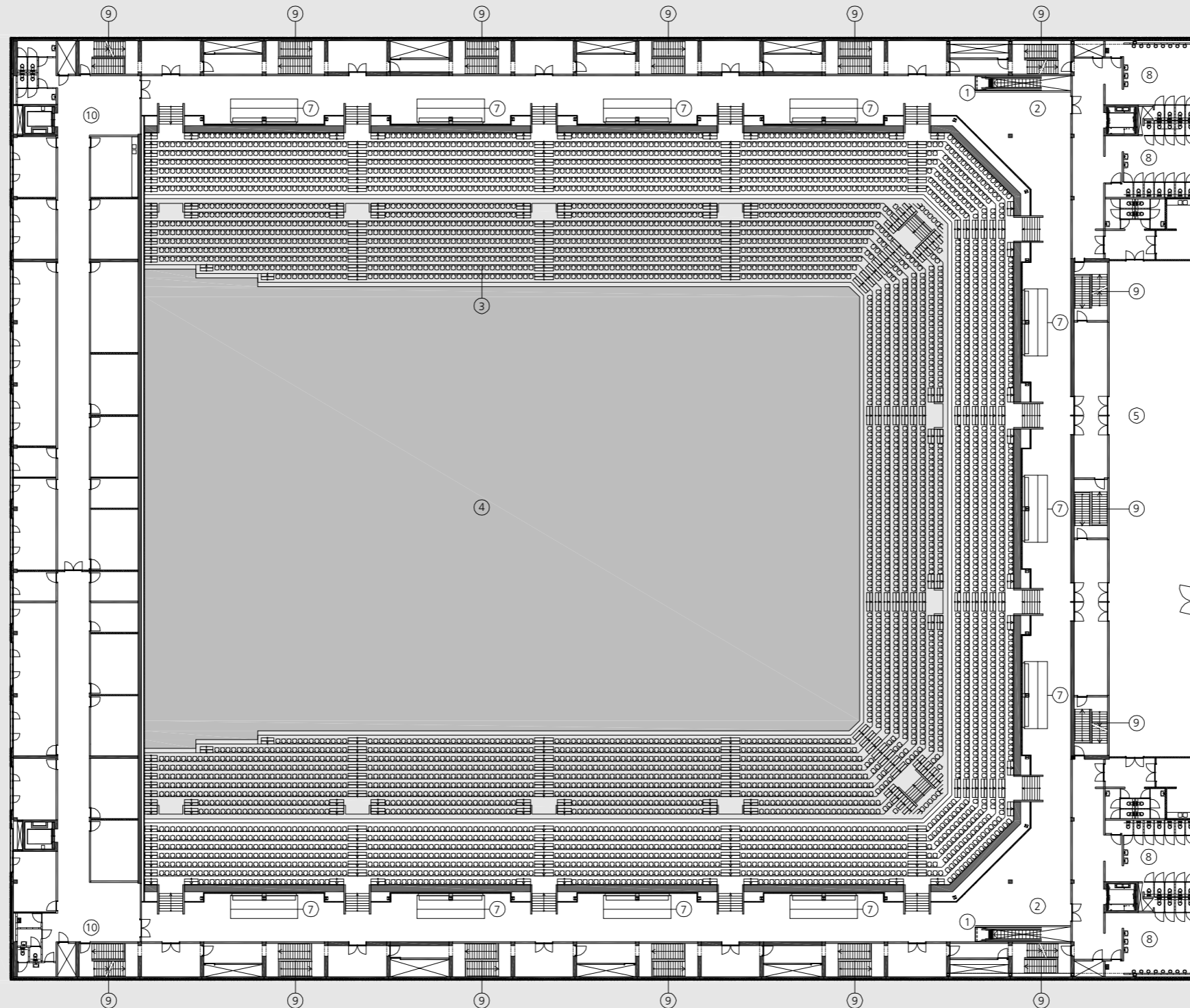

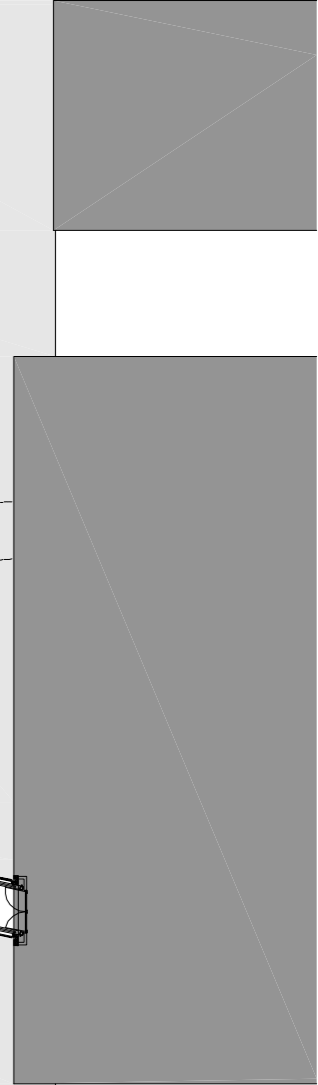
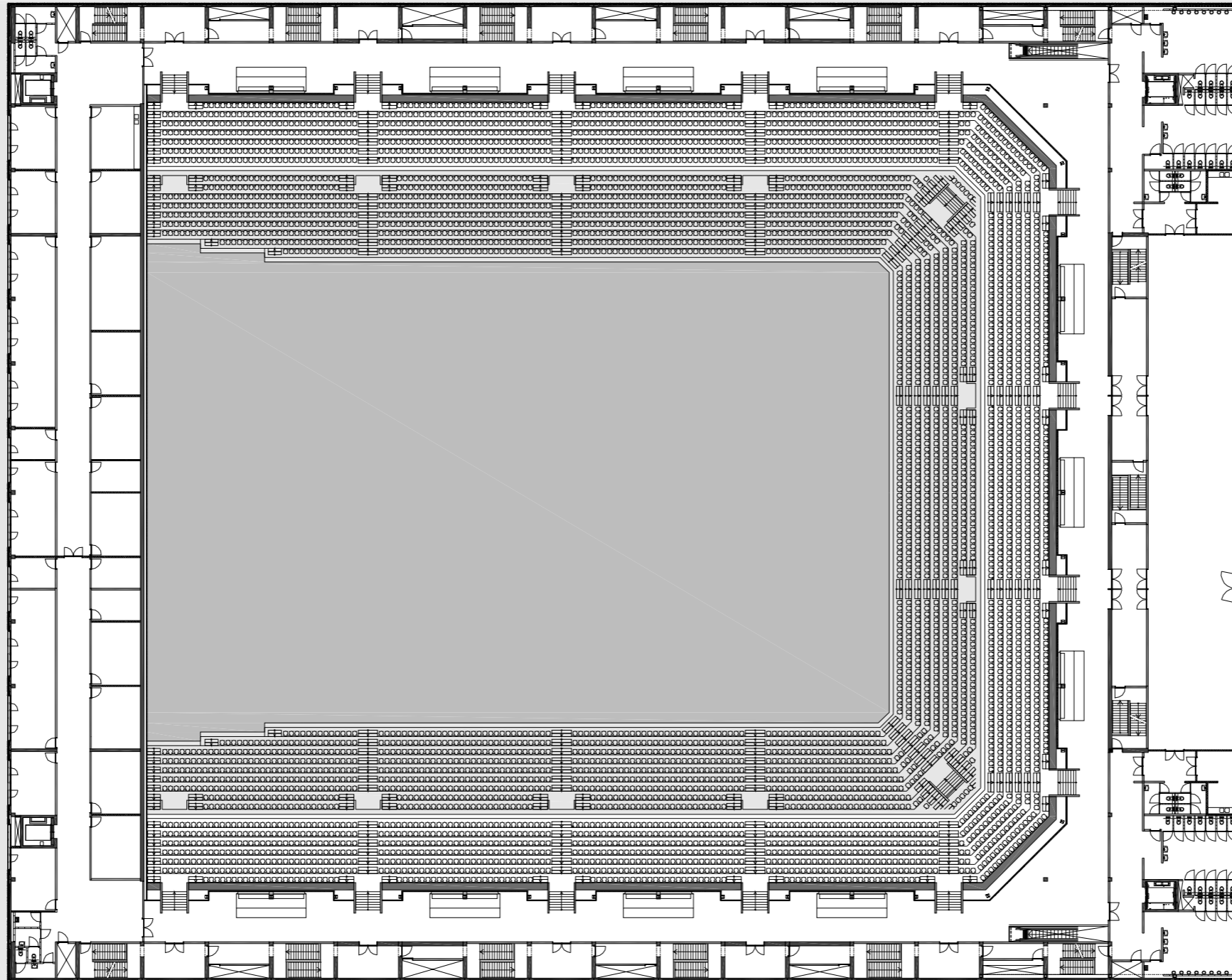

0 5 10 25m

1. Banqueting
2. Luchtbrug
3. Keuken
4. Toiletten
5. Volgspots
6. Licht regie
7. Backstage
8. VVIP rooms
9. Catwalks & rigging

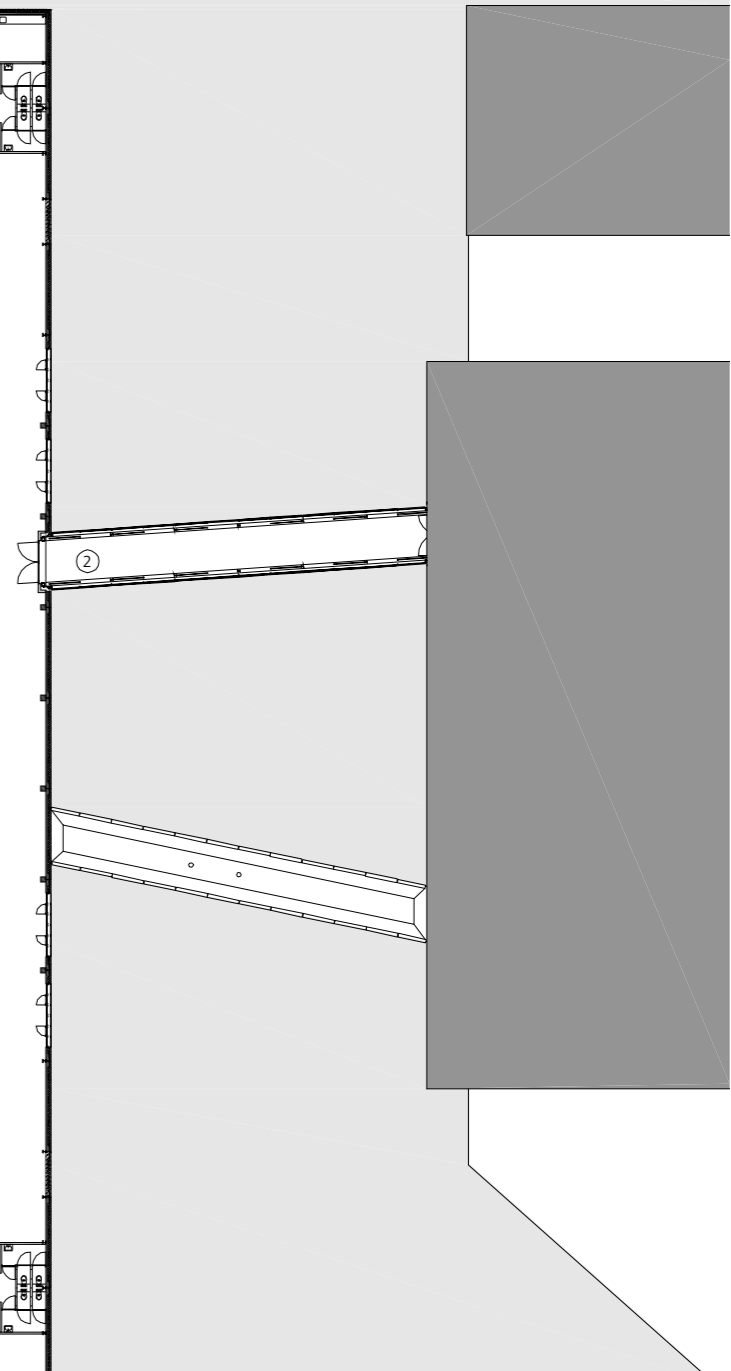
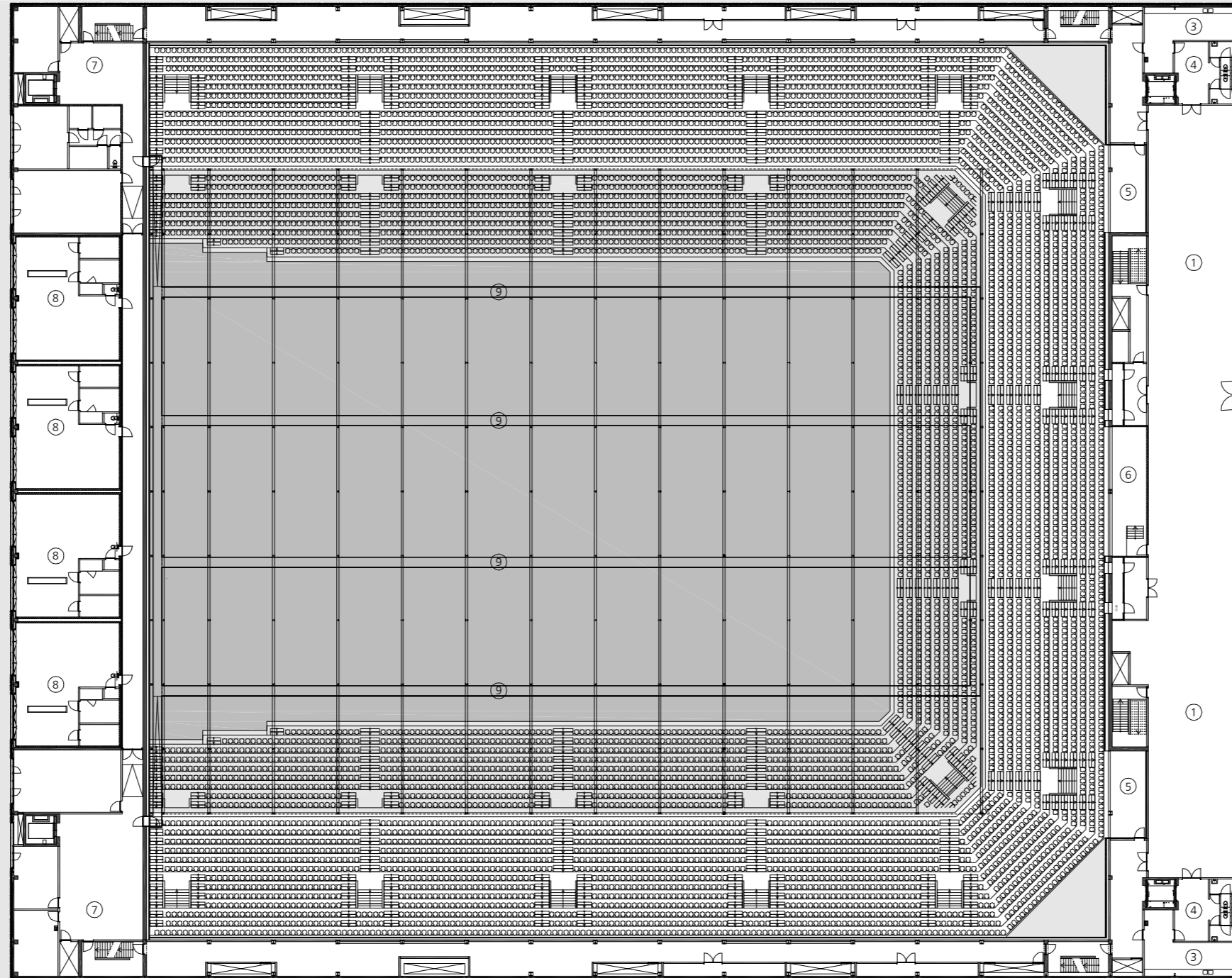

0 5 10 25m



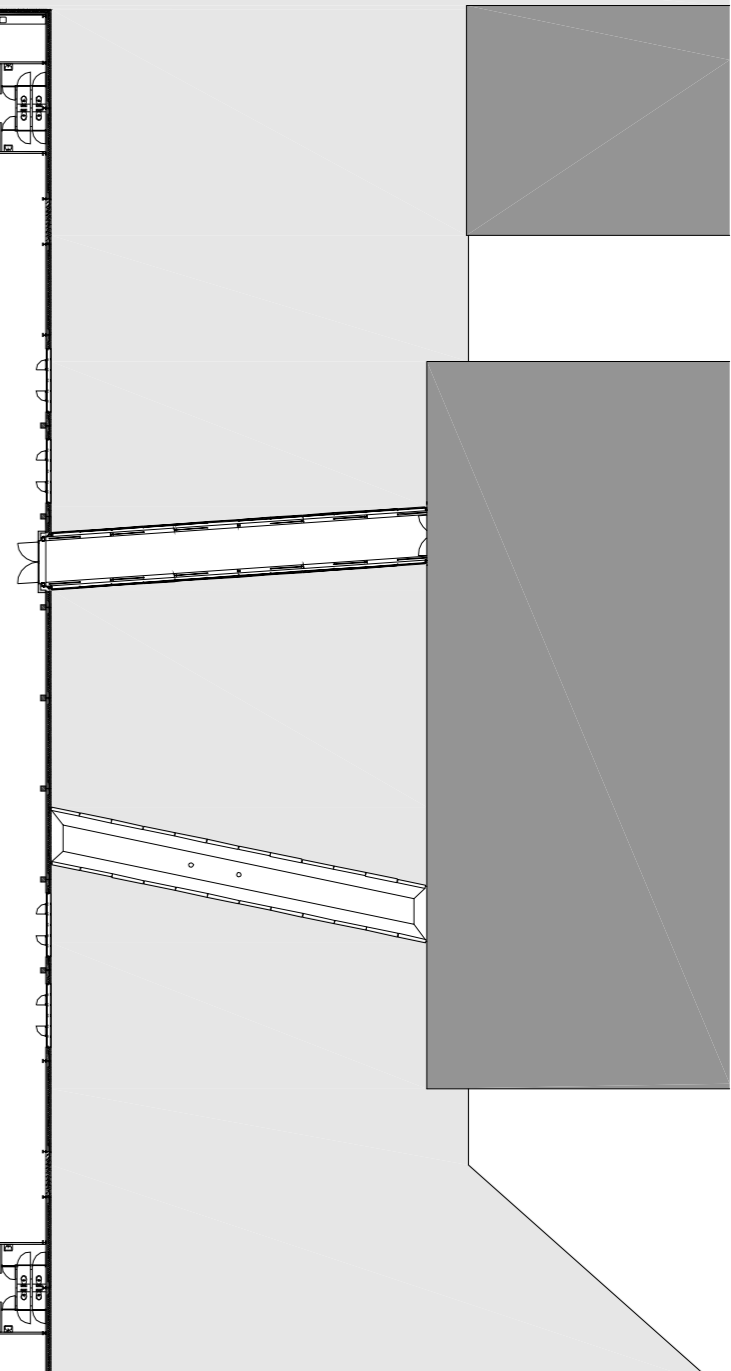
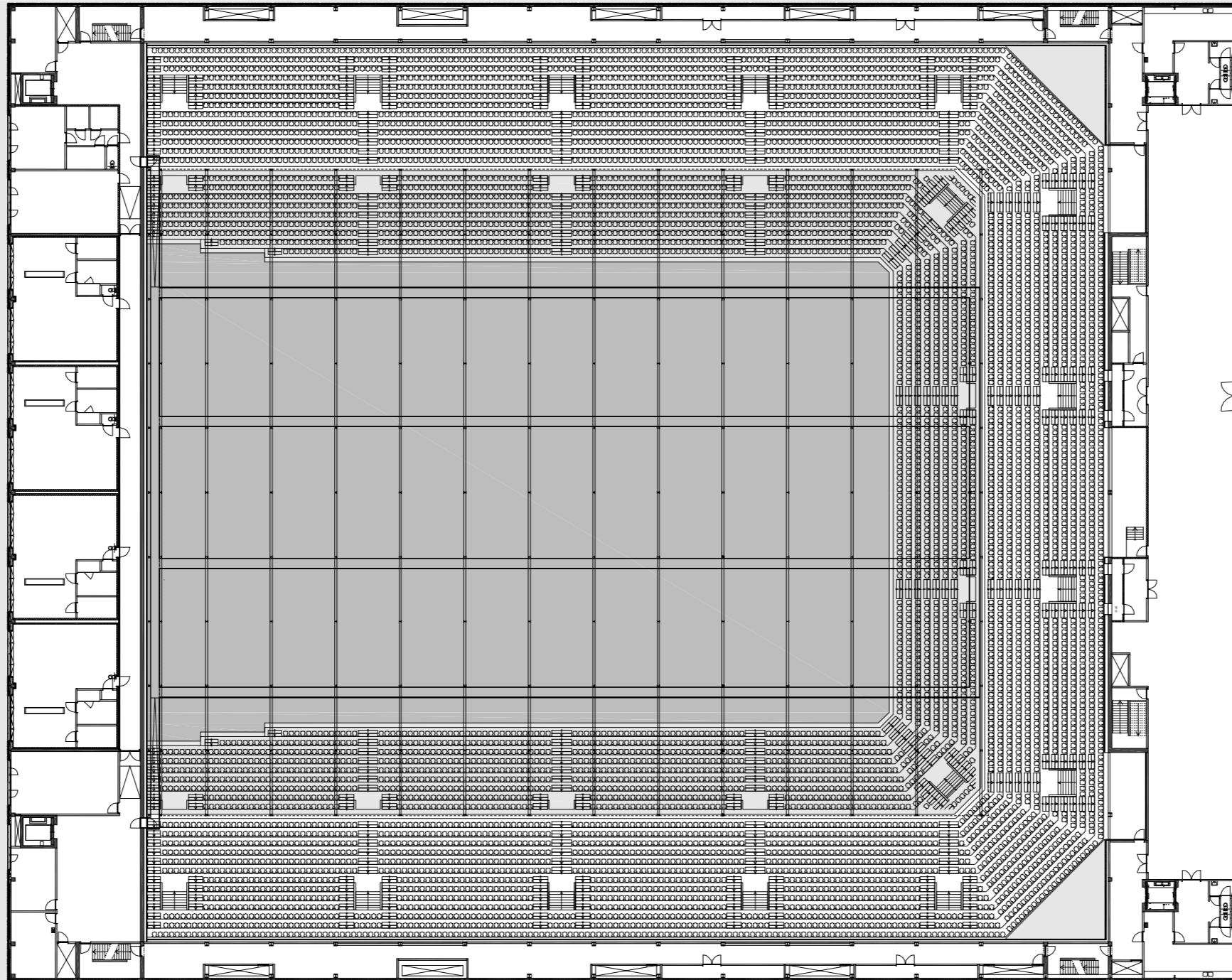

0 5 10 25m

- 1. Trappenhuis
- 2. Parkeerkelder
- 3. Opslag/ installaties

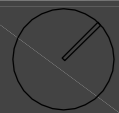
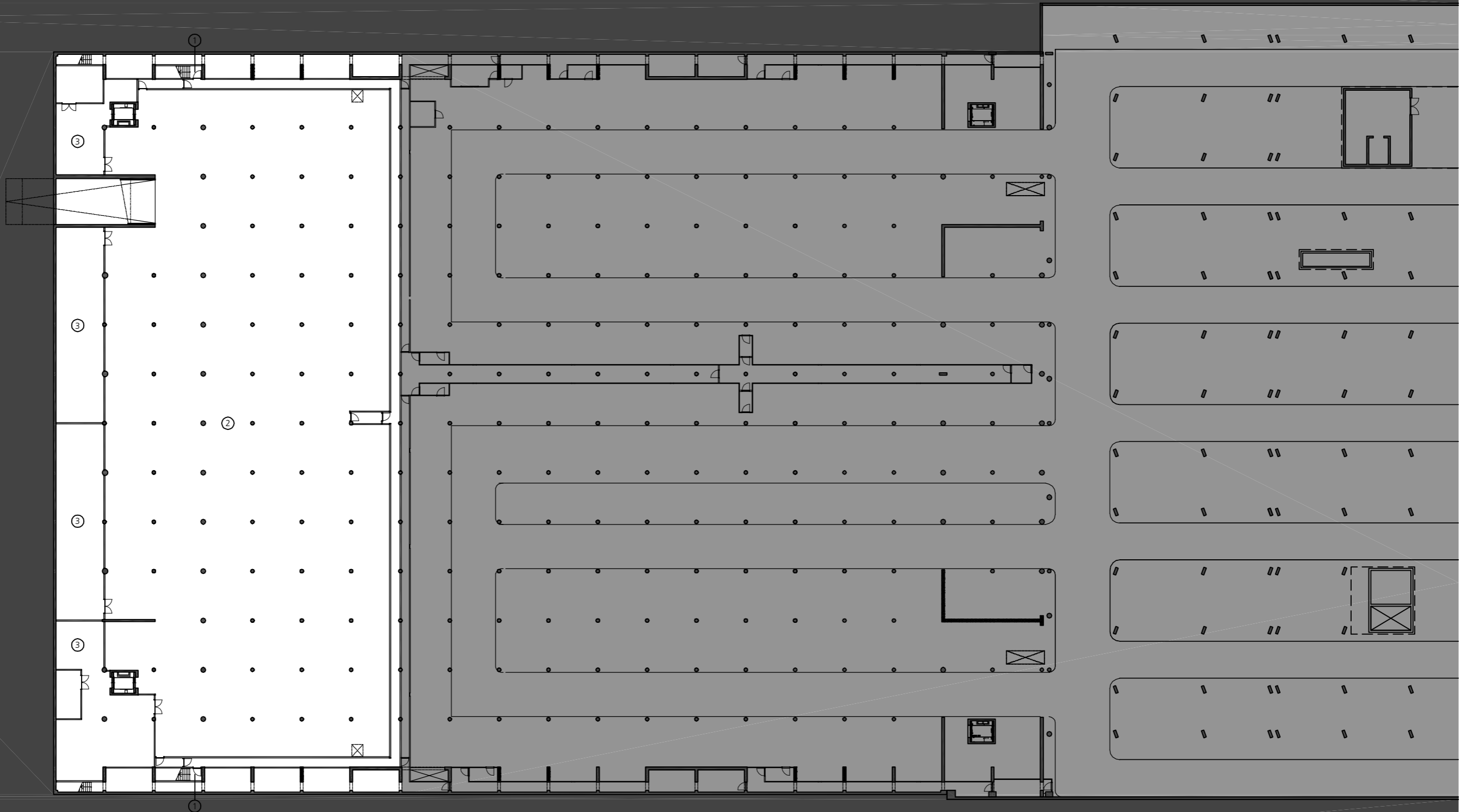

0 5 10 25m

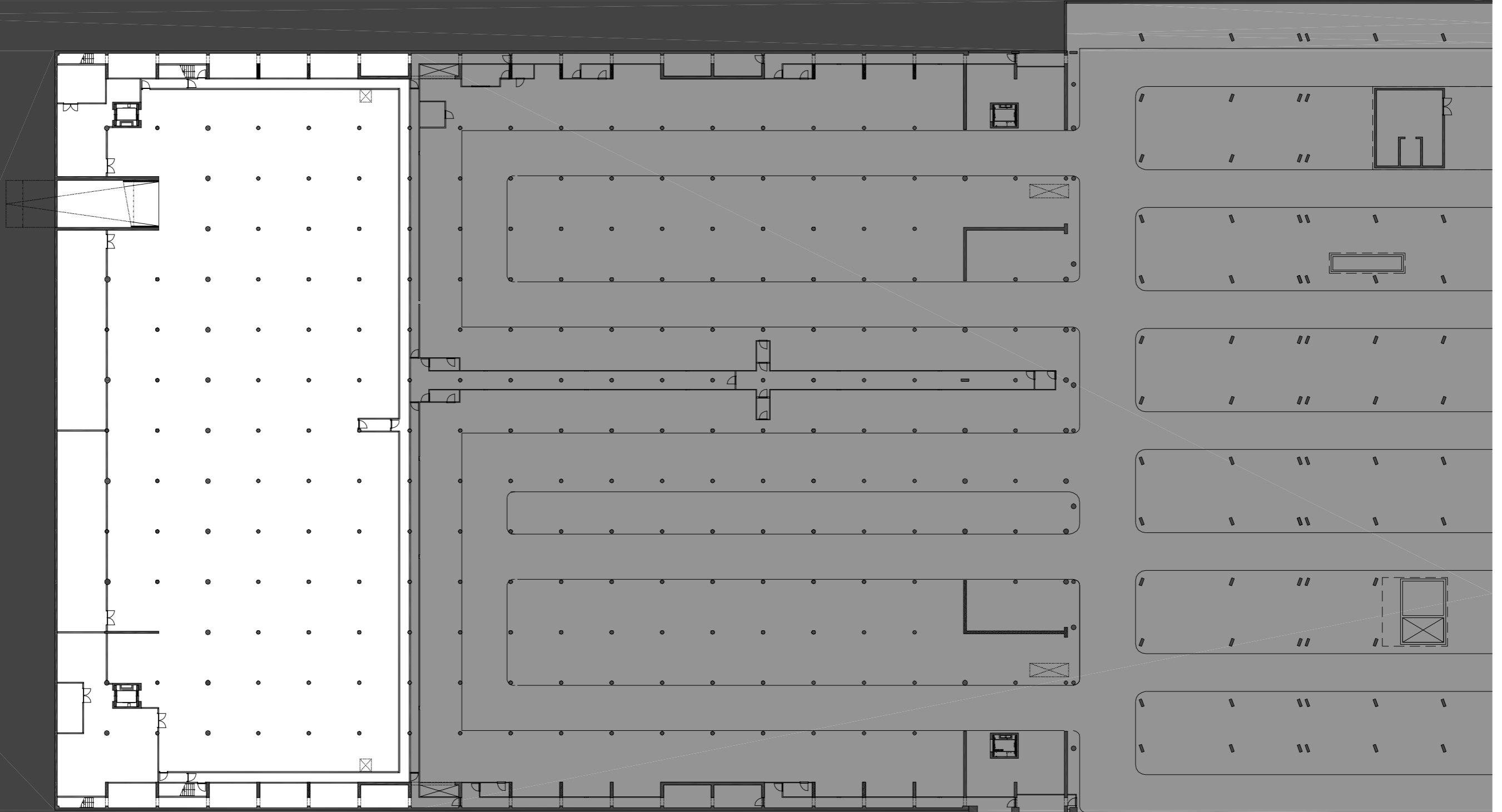

0 5 10 25m

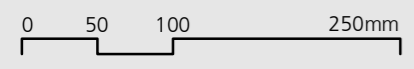
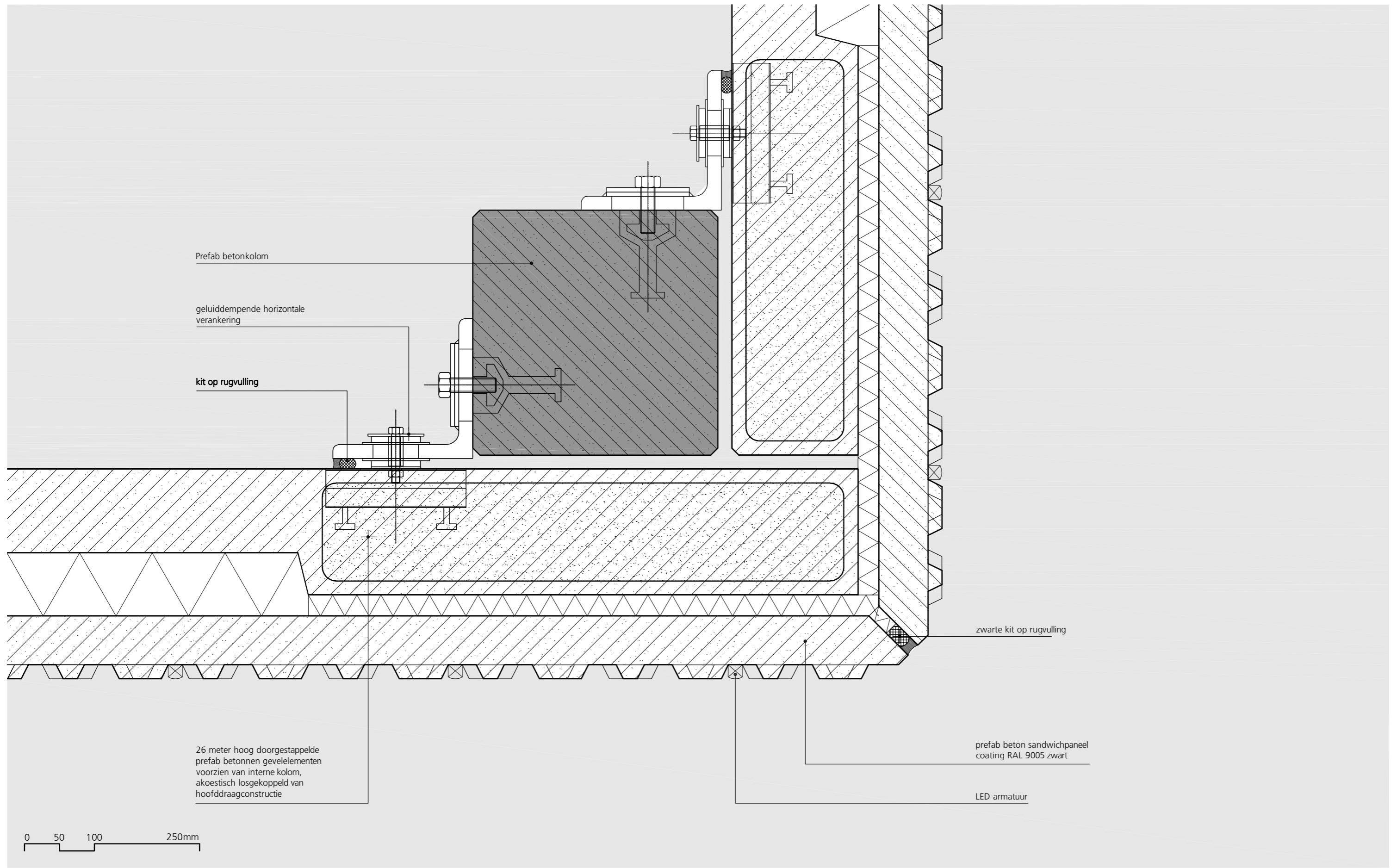

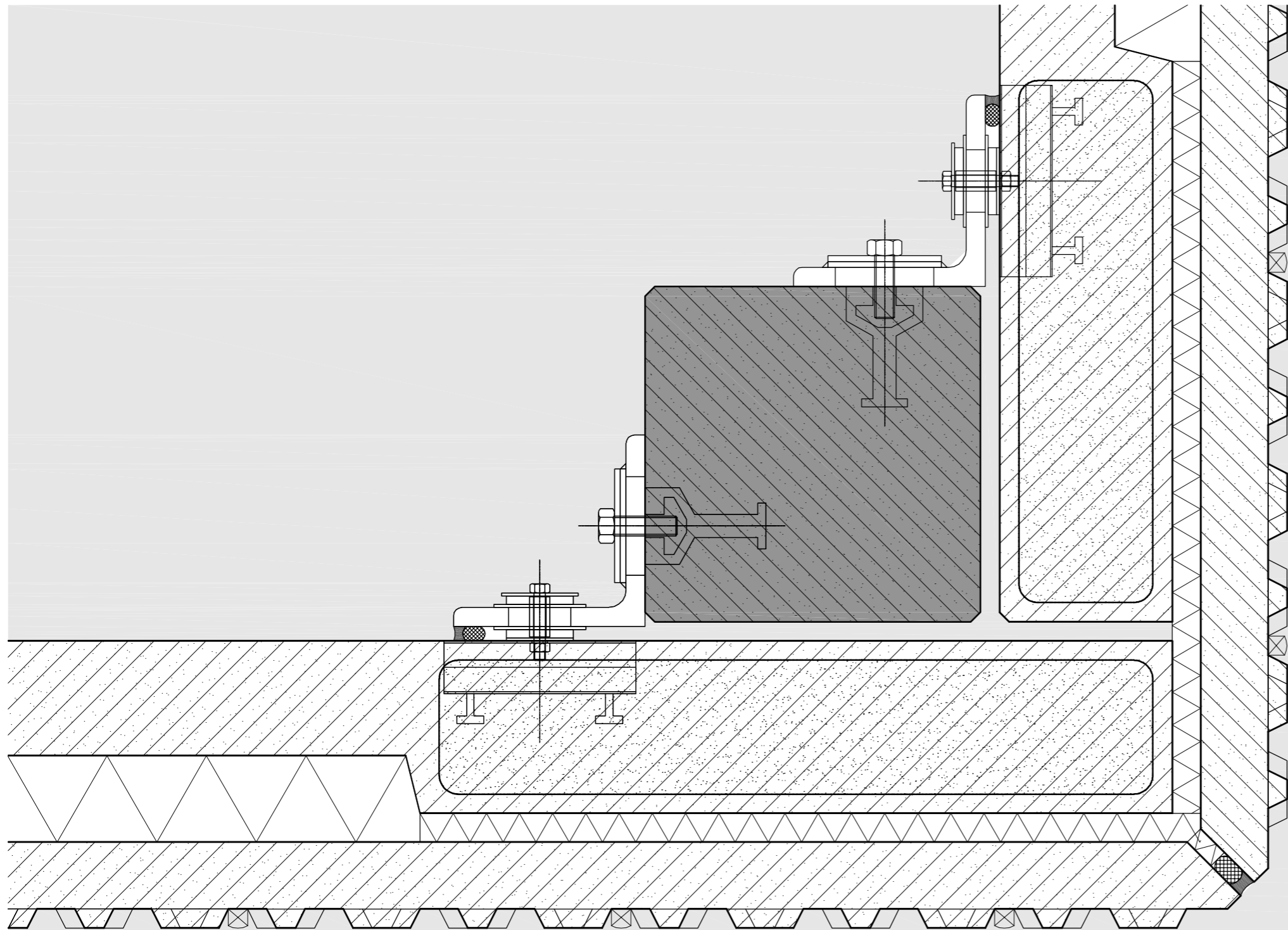

0 50 100 250mm

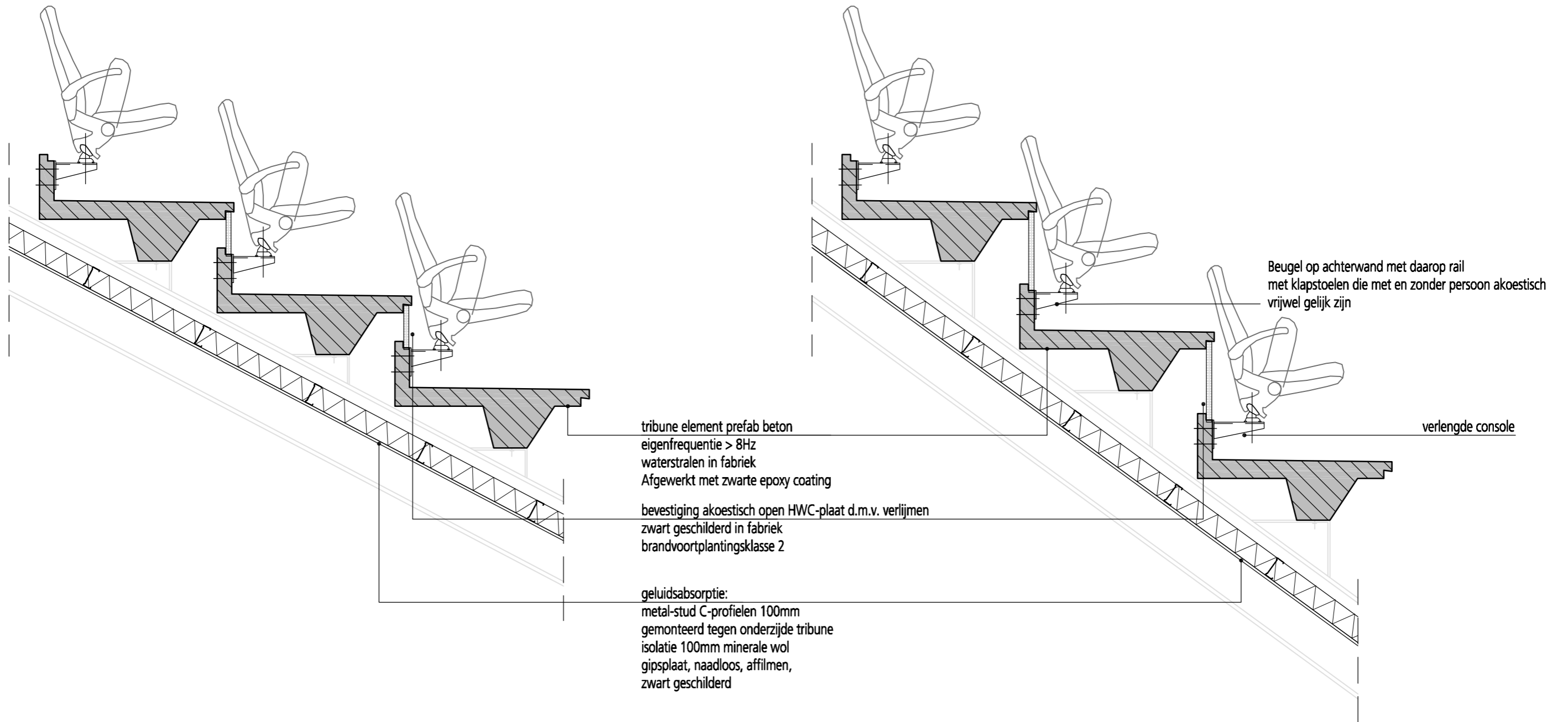

onderste tribune

bovenste tribune

0 200 400 1000mm

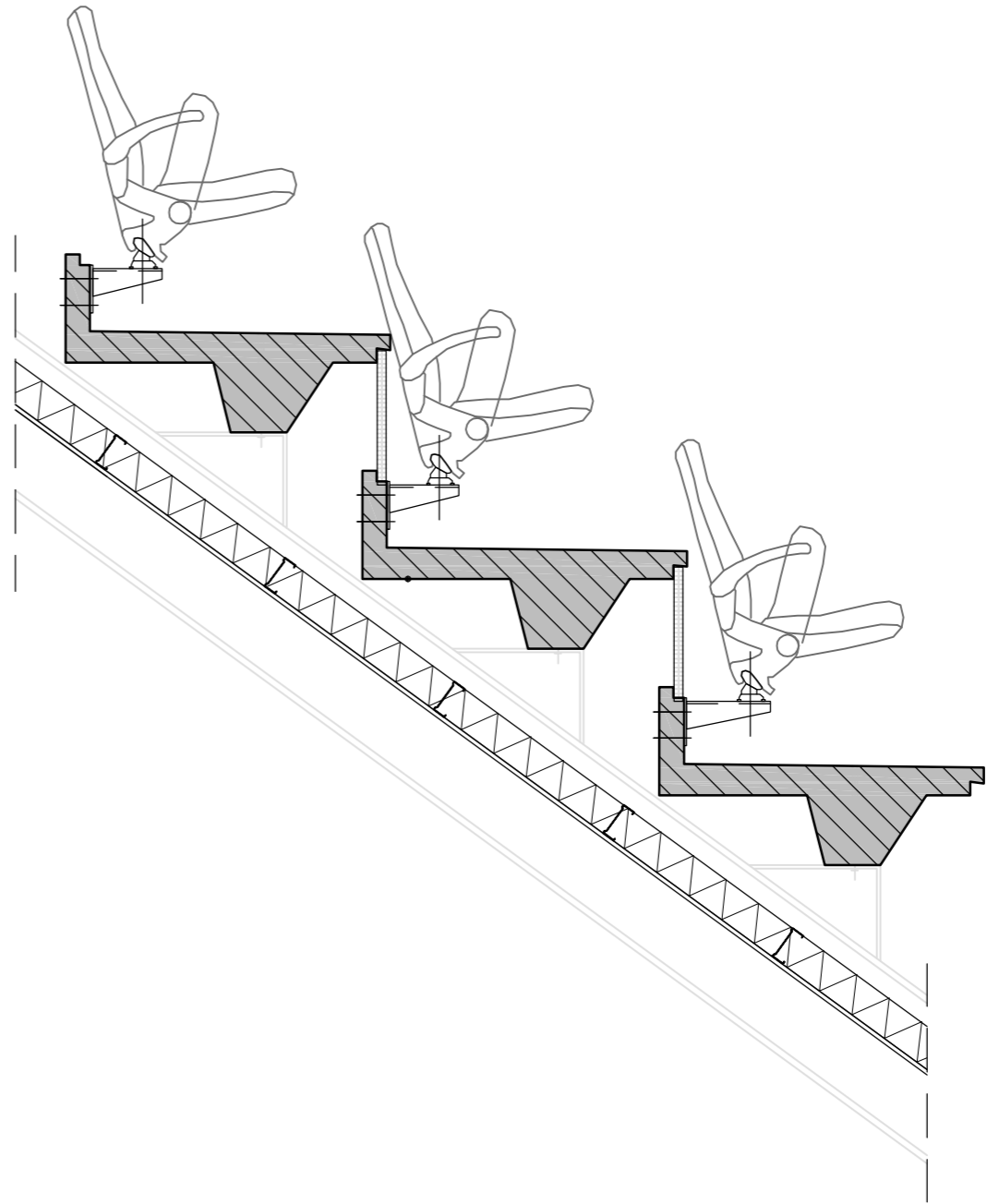
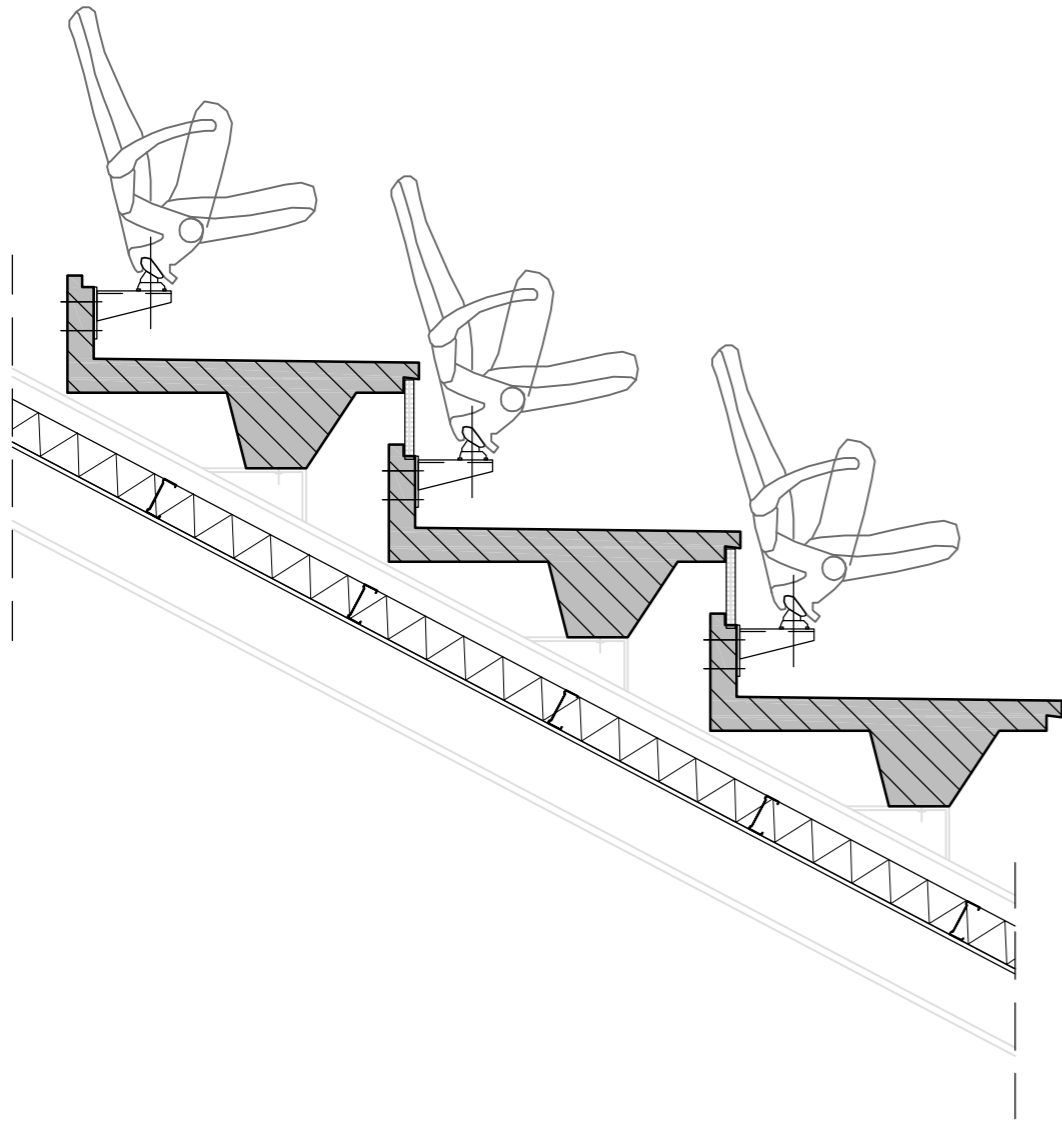

0 200 400 1000mm