

Situatie 1:2000

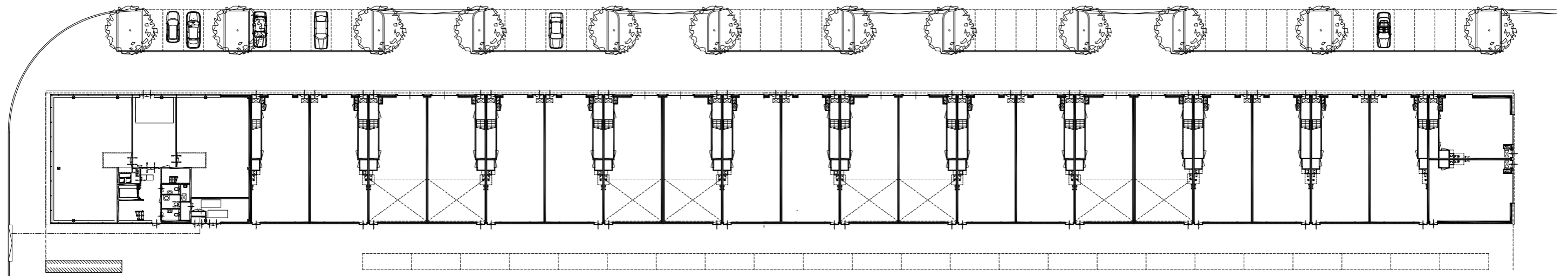

begane grond 1:500

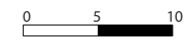

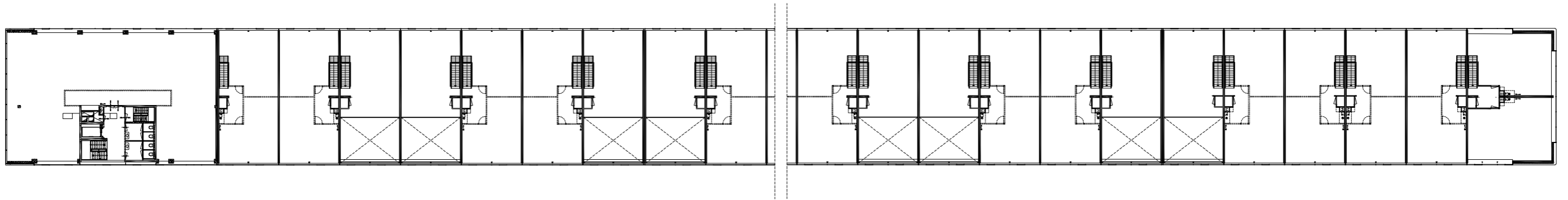

1e verdieping 1:500



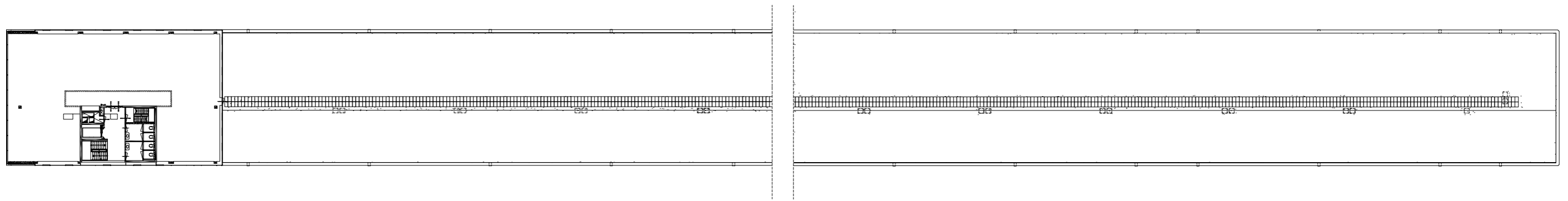

2e en 3e verdieping 1:500



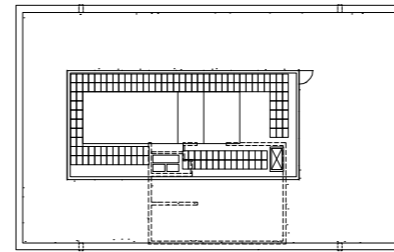
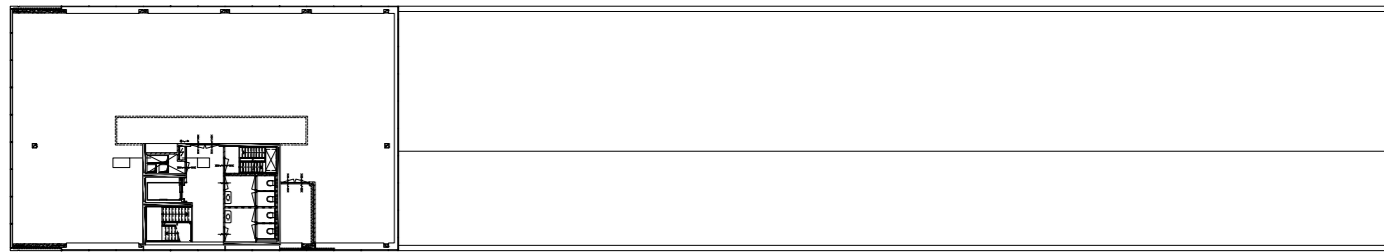

4e + 5e verdieping 1:500

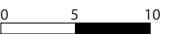



Noord- en Zuidgevel 1:500



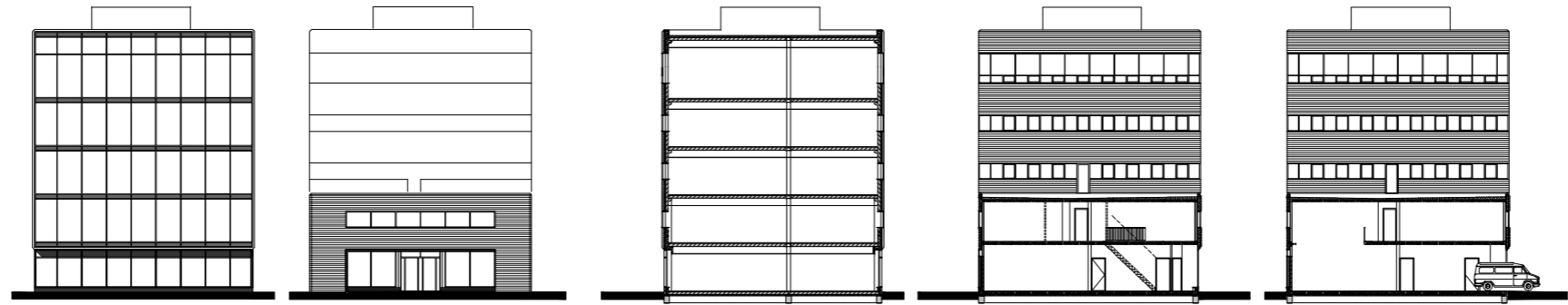

Oost- en Westgevel + doorsnede 1:500

