

Situatie

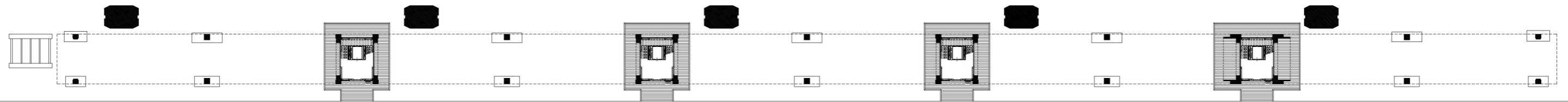

Begane Grond

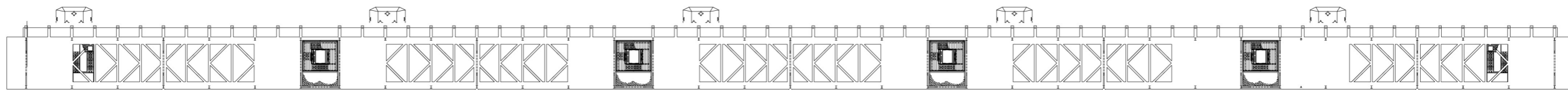

3e Verdieping

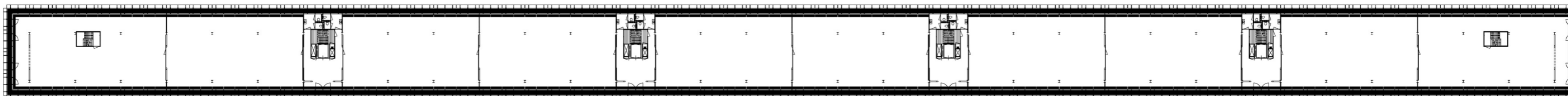

Plattegrond 4e 5e 6e Verdieping

0 m 10 m

# Plattegronden

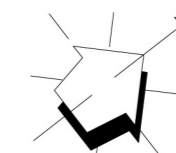

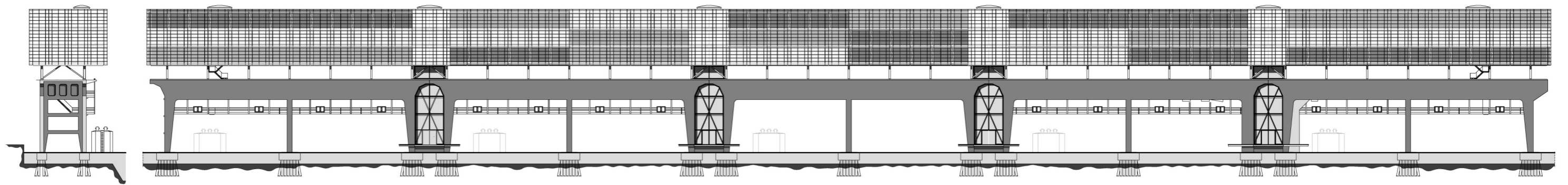

Gevel Landzijde

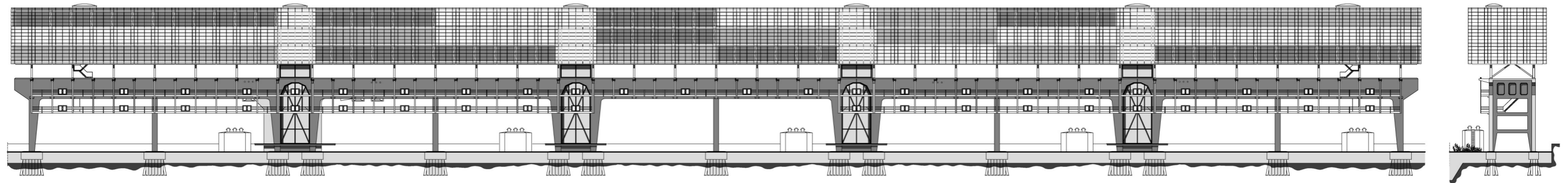

Gevel Waterzijde

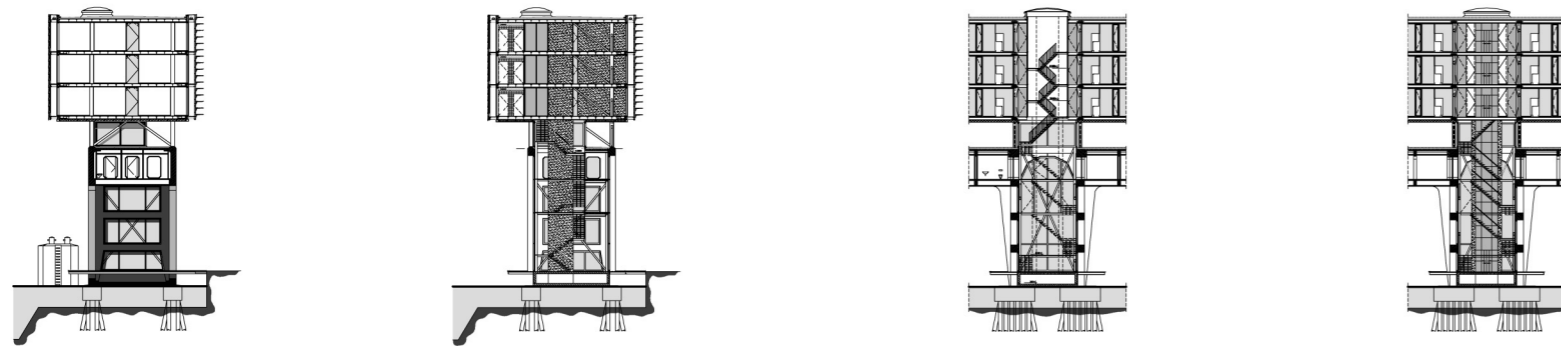

Dwars/ Lang-doorsneden

0 m 10 m

# Gevels - Doorsneden